

# SAILFISH 312 CC | OWNER'S MANUAL



## General Introduction

This manual has been compiled to help you to operate your craft with safety and pleasure. It contains details of the craft, the equipment supplied or fitted, its systems and information on their operation, set up, maintenance, prevention of risks and management of those risks. Please read carefully and familiarize yourself with the craft before using it.

This owner's manual is not a course on boating safety or seamanship. If this is your first craft, or if you are changing to a type of craft you are not familiar with, for your own comfort and safety, please ensure that you obtain handling and operating experience before "assuming command" of the craft. Your dealer or national boating/sailing federation or yacht club will be pleased to advise you of local sea schools, or competent instructors.

Ensure that the anticipated wind and sea conditions will correspond to the design category of your craft, and that you and your crew are able to handle the craft safely in these conditions.

Even when your boat is categorized for them, the sea and wind conditions corresponding to the design categories A, B and C range from severe gale conditions for category A, to strong conditions for the top of category C, open to the hazards of a freak wave or gust. These are therefore dangerous conditions, where only a competent, fit and trained crew using a well-maintained craft can satisfactorily operate.

This owner's manual is not a detailed maintenance or trouble-shooting guide. In the case of difficulty, refer to the boat builder or boat builder's representative. If a maintenance manual is provided, use it for the craft's maintenance.

Always use trained and competent people for maintenance, repair or modifications. Modifications that may affect the safety characteristics of the craft shall be assessed, executed and documented by competent people. The boat builder cannot be held responsible for modifications that boat builder has not approved.

2

In some countries, a driving licence or authorization is required, or specific regulations are in force and carriage requirements may be subject to local regulations.

Always maintain your craft properly and take into account the deterioration that will occur over time and as a result of heavy use or misuse of the craft.

Any craft, no matter how strong it may be, can be severely damaged if not used properly. Inspect the craft regularly especially after any kind of suspected damage. Always adjust the speed and direction of the craft to sea conditions.

If your craft is fitted with a liferaft, carefully read its operating manual. The craft should have on board the appropriate safety equipment (lifejackets, harnesses, etc.) according to the type of craft, weather conditions, etc. This equipment is mandatory in some countries. The crew should be familiar with the use of all safety equipment and emergency manoeuvring (man overboard recovery, towing, etc.). Sailing schools and clubs regularly organize training sessions.

All persons should wear a suitable personal floatation device (life jacket/ buoyancy aid) when on deck. Note that, in some countries, it is a legal requirement to wear a personal floatation device that complies with their national regulations. PLEASE KEEP THIS MANUAL IN A SECURE PLACE, AND HAND IT OVER TO THE NEW OWNER WHEN YOU SELL THE CRAFT.

Annex A from ISO 10240:2019(E)



# 2026 312 CENTER CONSOLE

*fuel your passion*



<b>LOA Hull Only</b> <b>30' 6"   9.03 M</b>	<b>Beam</b> <b>9' 9"   2.97 M</b>
<b>Length Rigged</b> <b>32' 6"   9.91 M</b>	<b>Fuel Capacity</b> <b>265 GAL   1,167 L</b>
<b>Cockpit Depth Bow</b> <b>37"   93.98 CM</b>	<b>Draft (Hull Only)</b> <b>18"   45.72 CM</b>
<b>Cockpit Depth Rear</b> <b>32"   81.28 CM</b>	<b>Max Horsepower</b> <b>800 HP   596.56 kW</b>
<b>Dead Rise (Multiangle)</b> <b>22°-24°</b>	<b>Fresh Water</b> <b>19 GAL   72 L</b>
<b>Bridge Clearance w/ Hard Top</b> <b>8' 6"   2.59 M</b>	

**Approx. Rigged Weight**  
**10,725 LBS | 4,864.78 KG**

<b>Yacht Certified</b>	<b>3</b>	<b>29</b>
<b>Person Capacity</b>	<b>Battery Capacity</b>	<b>Rod Holders (Standard)</b>

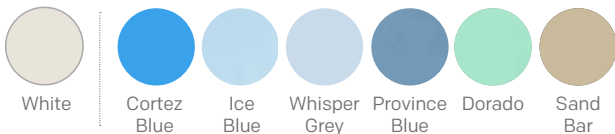

## STANDARD FEATURES

### Boat

- Backing Plates for Radar and VHF Mounts in Hard Top
- Black Caulk for Coaming Caps
- Boarding Ladder (4-Step w/ Grab Handle)
- Built-In Rigging Tubes (from Bilge to Helm w/ Pull Tapes)
- Carbon Fiber & Kevlar® Reinforced Deck & Hull
- Closed Cell Foam Flotation
- Cockpit Bolster Pads
- Deluxe Console (Integrated D Channel Hard Top Frame w/ Full Surround Three-Piece Glass Windshield w/ Windshield Wiper)
- Exclusive Dot Matrix Non-Skid Flooring
- Exclusive VDS Hull Design (Variable Deadrise Stepped Hull)
- Extended Transom with Built-In 21-qt. Cooler on Port Side
- Fiberglass Hard Top (w/ Rod Holders, PFD Storage, Electronics Box, Bi-Color Courtesy Lights and Front, Back & Side Spreader Lights)
- Fuel Filter / Water Separator
- Oversized Bilge w/ Electronically Actuated Access
- Port Side Dive Door (w/ Fold-Away Grab Handle)
- Powder Coat (White)
- Recessed SST Cup Holders (17)
- SailTech Composite Full Length Transom
- SailTech Foam-Filled Fiberglass Stringer System
- Side Door Ladder
- Thru Hull Windlass System (w/ Stainless Steel Anchor & Scuff Plate)
- Transom Mounted Tool & Raw Water Washdown Hose Holder
- Trim Tabs (Dual Ram, Heavy-Duty, High-Performance w/ Indicators & Auto-Retract Feature)
- Two Door Access in Console for Wiring Access
- Walk-Thru Transom Door w/ Wave Guard Step

### Bow

- SST Split Low Profile Bow Rails
- Dual USB Charging Ports (2 Port/Starboard)

### Electrical

- 6 Channel Amp
- Accessory Switch Panel w/ Circuit Breakers
- Compass
- Electric Horn
- Full Digital Instrumentation
- Fully NMEA 2K Compliant
- Fusion Stereo System w/ Rockford Fosgate LED Lighted Speakers
- LED Anchor Light
- LED Interior Cockpit & Bilge Lighting
- LED Navigational Bow Light
- VSR Battery Charging System

### Fishing

- 2 Circulating Baitwells w/ LED Lighting (30-gal. Transom / 32-gal. Leaning Post)
- Cockpit Toe Rails
- Insulated Bow Fish Boxes (Twin w/ Overboard Drains)
- Recessed Rod Storage (Starboard)
- SST Rod Holders (14)
- SST Transom Rod Holders
- Twin Insulated In-Floor Aft Fish/Storage Boxes w/ Overboard Pump-Out System

### Hardware

- Fender Cleats (4)
- Flush Mount Hinges, Latches & Deck Plates

- Heavy-Duty SST Bow & Stern Eyes
- Heavy-Duty SST Rub Rail
- Marine Grade SST Hardware
- Sailfish Engraved Transom Plates
- SST & Bronze Thru Hull Fittings
- SST Flush Mount Pull-Up Cleats (6)
- SST Propellers

### Head

- Electric Marine Head (w/ 7.5 gal. Holding Tank, Overboard Discharge & Deck Pump-Out Fitting)
- Head Compartment Lighting
- Lockable Head Door
- Mirror
- Marine Deck Flooring (Foam)
- Sink w/ Faucet/Pull-Out Shower
- Port Light

### Helm

- Digital Electric Steering (Yamaha)
- Digital Electric Steering (Mercury 350 / 400 Verado)
- Power-Assisted Hydraulic Steering (Suzuki & Mercury 300 Verado)
- Tilt SST Steering Wheel w/ Power Knob
- Vinyl Covered Glove Box w/ 12-Volt DC Accessory Plug

### Plumbing

- Automatic Bilge Pumps (2 -2000 GPH Aft and 1 - 800 GPH Forward)
- Freshwater Shower (Transom)
- High-Speed Livewell Pickup
- Raw Water Washdown
- Self-Bailing Cockpit

### Seating

- Built-In Insulated & Upholstered Forward Helm Cooler Seat
- Fold Away Transom-Mounted Aft Bench Seat w/ Self-Rising Backrest
- Leaning Post (w/ 35-gal. Livewell, Sink w/ Faucet, Power Activated Captain's Chair w/ Armrests & Storage)
- Self-Rising Lever-Activated Forward Facing Bow Backrests
- Starboard Side Aft Fold Out Seat (36")

### Storage

- Battery Storage (Head)
- Console Top Tackle Organizer ("CTO", w/ Dual USB Charging Ports)
- Footrest Console Storage
- In-Floor Storage (Bow, w/ Bucket Holder)
- Rear Entry Under-Step Storage
- Starboard Aft Hanging Rope Locker
- Vanity Storage (in Head)

## OPTIONS

### Boat Options

- LED Light Bar (White)
- 90" Garmin Force Kraken Motor w/36V Lithium Battery
- Batteries (1 house/2 cranking) - 27 series
- Bow Rod Holders
- Bow Shower
- Bow Thruster
- Captain's Anti-Fatigue Pad

## OPTIONS (Continued)

- Console & Leaning Post Covers
- Hella Underwater LED Lights (2)
- Laporte Cockpit Sunshade (White)
- Leaning Post Rod Rack (4)
- Yamaha Helm Master w/ Joystick
- Marine Deck Flooring (Foam) - Entire Cockpit Deck
- Mercury Electric Steering w/ Joystick (300 Verado)
- Mercury Joystick (350 & 400 Verado)
- Optimus Joystick (Suzuki)
- Refrigerator - Drawer Style 2.8 cu ft. (Eliminates LP Livewell)
- Removable Bow Table
- Retractable Ski Tow Pylon
- Seakeeper Ride System
- Trolling Motor Pre-Wire
- Two-Tone Hard Top
- Wireless Cell Phone Charger/Holder

### Electrical Options

- Built-In 3 Bank Battery Charger
- Fusion Transom Remote Control
- Garmin GMR™ 18 xHD Radome
- Garmin GpsMap Twin - (1) 124.3xsv w/o Transducer, (1) 124.3
- Garmin GpsMap Twin - (1) 164.3xsv w/o Transducer, (1) 164.3
- Garmin Thru Hull Transducer GT-12M w/ CHIRP
- Garmin Thru Hull Transducer GT-15M w/ CHIRP
- Garmin VHF Radio & Antenna
- Radar Cable & Power Cable
- Simrad Halo24 Pulse Compression Radome
- Simrad Twin NSX 3012 w/o Transducer
- Simrad Twin NSO EVO3 16" MFD w/o Transducer
- Simrad B60 Airmar Thru Hull Transducer w/o CHIRP
- Simrad B75 Airmar Thru Hull Transducer w CHIRP
- Simrad VHF Radio & Antenna
- Upgrade Trolling Motor Battery Charging System (12V to 36V)

### Seating Options

- Bow Filler Cushion

### Optional Packages

#### Entertainment Package

- Retractable Ski Tow Pylon, Removable Bow Table, Fusion Transom Remote Control & Hella Underwater LED Lights (2)

### Engine Options

#### Yamaha

- Twin Yamaha F300USB2 (White)
- Twin Yamaha F350USA2 (White)

#### Mercury

- Twin Mercury 300XXL Verado V8 (Warm Fusion)
- Twin Mercury 350XXL Verado V10 (Warm Fusion)
- Twin Mercury 400XXL Verado V10 (Warm Fusion)

#### Suzuki

- Twin Suzuki DF300APXXW5 (White)
- Twin Suzuki DF350ATXXW5 (White)



sailfishboats.com

Specifications, features, equipment, options, colors, materials and trim are based on information available at time of printing and are subject to change without notice. Some accessories shown in photographs, or described, may not be standard equipment or even available as an option(s). Confirm availability of all accessories and equipment with an authorized Sailfish Boats dealer prior to purchase. © 2025 Sailfish Boats.



V5 10/16/2025

# SAILFISH 312 CC | OWNER'S MANUAL - TABLE OF CONTENTS

2. Introduction
3. Boat Specifications
5. Craft Design Category and General Warnings
6. Boat Trailer Measurement
7. Towing and Anchoring Strong Points
8. Stability & Buoyancy
9. Boat Layout
10. Seating / Occupant Locations
11. Boat Safety & Warning Labels
13. Boat Safety & Warning Label Locations
14. Boat Safety & Warning Label / Navigation Light Replacements
15. Unassisted Boarding Situations
16. Battery Switch Wiring Schematic
17. Breaker Panel Schematic
18. Switch Panel Schematic
19. Forward Hull Harness
20. Aft Hull Harness Schematic
21. Deck Harness Schematic
22. Hard Top Harness Schematic
23. Fuel System Layout
24. Plumbing Diagram
25. Dash Layout
26. Ignition Switches & Engine Shut-Off Cord/Lanyard
27. Wiring and Fuel Maintenance
28. Console / Head Area
29. Hardtop Layout
31. VSR Battery System
32. Bilge Access and Explanation
33. Bilge Pumps
34. Raw Water Washdown System
35. Freshwater Washdown and Shower System
36. Livewell Operation
37. Fishbox Pump
38. Optional Retractable Ski Tow Pylon
39. Bennett Trim Tab Maintenance
40. Windlass
41. Windlass Troubleshooting Chart
42. Uflex Power Assist Steering
43. Yamaha Helm Master EX Steering System
44. Optional Optimus Joystick
45. Optional Mercury Electric Steering
46. Optional Mercury Joystick
47. Console Top Organizer ("CTO") 4
48. Marine Head With Waste Tank (Type III MSD Waste Management System)
56. Vinyl Care and Cleaning
57. Aluminum Cosmetic Corrosion (Pitting)
58. Caring for Aluminum
59. Caring for Stainless Steel
60. Windshield Washing & Care
61. Seakeeper Ride Care
61. Gel Coat
63. Sailfish Boats Limited Warranty

## Craft Design Category: C

A Craft given design category C is considered to be designed to operate in typical steady winds of Beaufort force 6 or less and the associated significant waves heights of up to 2m.

**NOTE:** Typically, such conditions might be encountered on exposed inland waters, in estuaries, and in coastal waters in moderate weather conditions. Depending on atmospheric conditions, winds can gust to about 18m/s

## Before operating your vessel:

- Be aware of local environment laws, and respect codes of good practice.
- Be aware of international regulations against marine pollution (MARPOL).
- Secure loose equipment safely when underway.
- Do not operate the craft with an engine of rated power greater than the maximum recommended.
- Avoid sudden maneuvers at speed and reduce speed in high or rough seas.

## WARNING - Never:

- -work on the electrical installation while the system is energized;
- -modify the craft's electrical system or relevant drawings. Installation, alteration and maintenance should be performed by a competent marine electrical technician;
- -alter or modify the rated current amperage of overcurrent protective devices;
- -install or replace electrical appliances or devices with components which exceed the rated current amperage of the circuit;
- -leave the craft unattended with the electrical system energized, except automatic bilge pump, fire protection and alarm circuits.

5

## WARNING — To minimize shock and fire hazards:

- -Turn off craft's shore power connection switch before connecting or disconnecting shore power cable.
- -Connect shore power cable to craft's inlet before connecting to shore power source.
- -If reverse polarity indicator is activated, turn off craft's shore power connection switch immediately (if fitted).
- -Disconnect shore power cable at shore power source first.
- -Close shore power inlet cover tightly.

**WARNING** — Do not allow shore power cable end to hang in the water. An electrical field can result which can cause injury or death to nearby swimmers.

# SAILFISH 312 CC | OWNER'S MANUAL - TRAILER MEASUREMENT CHART

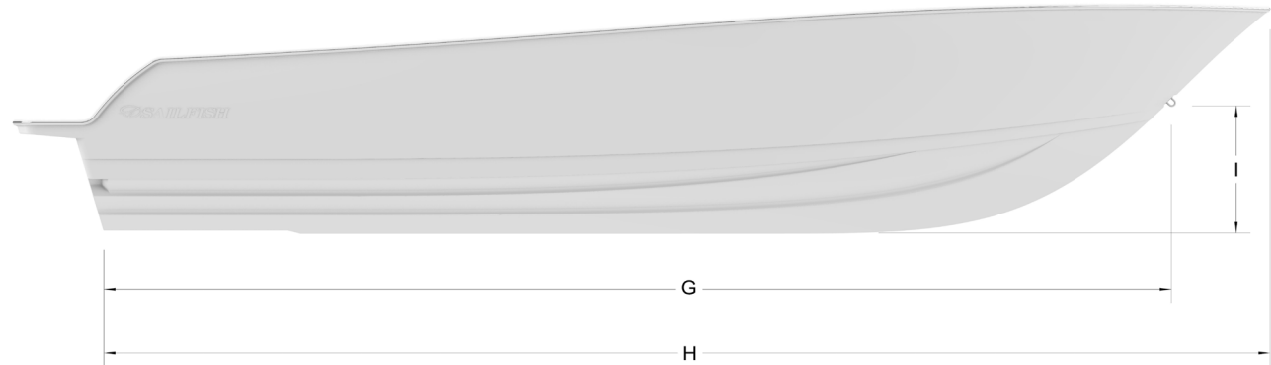
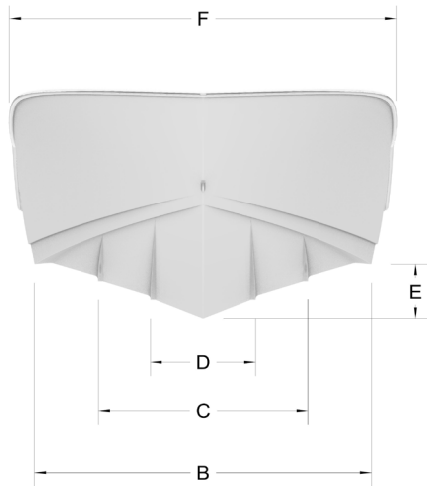

6

Boat Model	B	C	D	E	F	G	H	I
312CC	103 in.	64 in.	32 in.	16.5 in	114 in.	324 in.	355.5 in.	40.5 in.

Weight of boat when on trailer (5217 kg, 11,500 lbs.)

\*\*Warning – Use trailer suitable for craft mass

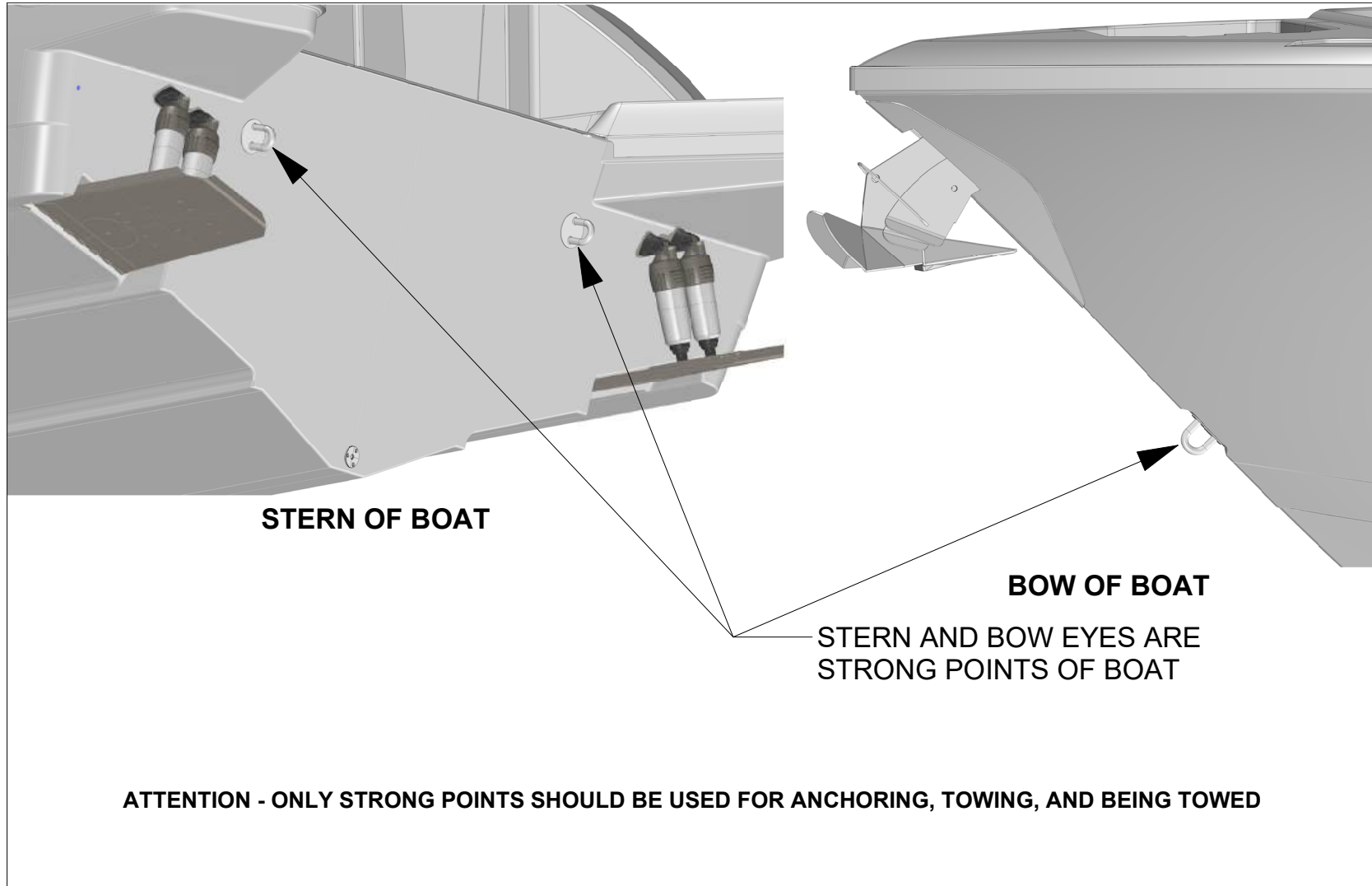

TO MAINTAIN GOOD STABILITY PLEASE BE AWARE OF THE FOLLOWING:

- Any change in the disposition of the masses aboard (for example, the addition of a fishing tower, a radar, a stowing mast, change of engine, etc.) may significantly affect the stability, trim and performance of the craft;
- Bilge water should be kept to a minimum;
- Stability is reduced by any weight added above the main deck;
- In rough weather, hatches, lockers, and doorways should be closed to minimize the risk of flooding;
- Breaking waves are a serious stability hazard.



# SAILFISH 312 CC | OWNER'S MANUAL - BOAT LAYOUT

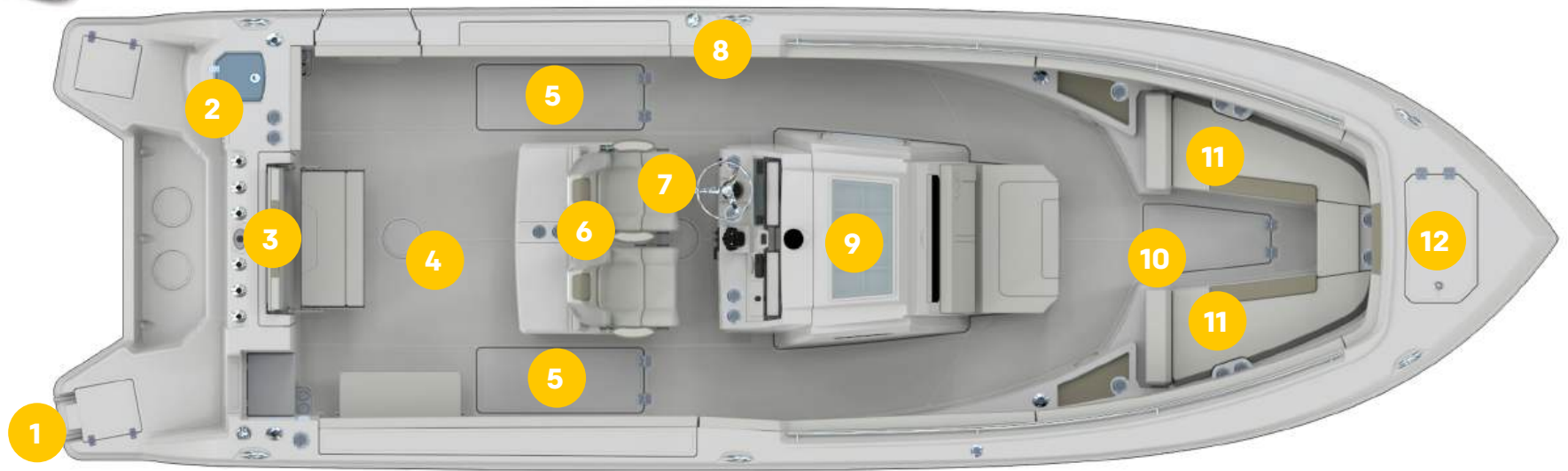

KEY	DESCRIPTION
1	Boarding Ladder / Fresh Water Fill
2	30 Gallon Livewell
3	Bilge Access
4	Fuel Sender and Pick-Up Access
5	In Floor Fish Boxes
6	Leaning Post

KEY	DESCRIPTION
7	Helm Area
8	Fuel Fill
9	Console and Head Area
10	Floor Storage
11	Insulated Fish Boxes
12	Anchor Locker

# SAILFISH 312 CC | OWNER'S MANUAL - SEATING / OCCUPANT POSITIONS



10

# SAILFISH 312 CC | OWNER'S MANUAL - BOAT SAFETY & WARNING LABELS

**⚠ WARNING**

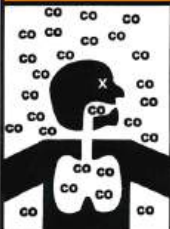

**Carbon monoxide (CO)** can cause brain damage or death.

Engine and generator exhaust contains odorless and colorless carbon monoxide gas.

Signs of carbon monoxide poisoning include nausea, headache, dizziness, drowsiness, and lack of consciousness.

Get fresh air if anyone shows signs of carbon monoxide poisoning.

See Owner's Manual for information regarding carbon monoxide poisoning.

NW-204-24

**⚠ DANGER**



**Carbon monoxide (CO)** can cause brain damage or death.

Engine and generator exhaust contains odorless and colorless carbon monoxide gas.

Carbon monoxide will be around the back of the boat when engines or generators are running.

Move to fresh air if you feel nausea, headache, dizziness, or drowsiness.

NW-206-23

**⚠ DANGER**

- **CONTACT WITH A SPINNING PROPELLER WILL CAUSE SERIOUS INJURY OR DEATH.**
- **SHUT OFF ENGINES** while people are in the water near the boat, on the swim platform, or on the boarding ladder.
- **NEVER OPERATE IN REVERSE TOWARD A PERSON** in the water.



NW-300-23

**⚠ DANGER**



**CONTACT WITH A SPINNING PROPELLER WILL CAUSE SERIOUS INJURY OR DEATH.**

**STAY CLEAR OF BOAT AND STAY OFF SWIM PLATFORM AND BOARDING LADDER WHILE ENGINE IS RUNNING.**

NW-301-23

As a boat owner, you need to become familiar with the locations of the Caution, Warning and Danger Labels found on your boat in order to ensure your safety, as well as everyone on board.

These are images of the labels to help you maintain and operate your boat safely.

NW-502-19

**⚠ WARNING**

Operating, servicing and maintaining a recreational marine vessel can expose you to chemicals including engine exhaust, carbon monoxide, phthalates, and lead, which are known to the State of California to cause cancer and birth defects or other reproductive harm. To minimize exposure, avoid breathing exhaust, service your vessel in a well-ventilated area and wear gloves or wash your hands frequently when servicing this vessel. For more information go to [www.P65warnings.ca.gov/marine](http://www.P65warnings.ca.gov/marine).

**(California Only )**

# SAILFISH 312 CC | OWNER'S MANUAL - BOAT SAFETY & WARNING LABELS

## Warning Labels Continued

The safety for you and everyone on board, as a boat owner, you need to become familiar with and the locations of the Caution, Warning and Danger Labels found on your boat.

Below are images of the labels to help you maintain and operate your boat safely.





# SAILFISH 312 CC OWNER'S MANUAL - LABEL LOCATIONS

**⚠ DANGER**



**CONTACT WITH A SPINNING PROPELLER WILL CAUSE SERIOUS INJURY OR DEATH.**

**STAY CLEAR OF BOAT AND STAY OFF SWIM PLATFORM AND BOARDING LADDER WHILE ENGINE IS RUNNING.**

999-001-03

**⚠ DANGER**



Carbon monoxide (CO) can cause brain damage or death. Engine and generator exhaust contains odorless and colorless carbon monoxide gas. Carbon monoxide will be around the back of the boat when engines or generators are running. Move to fresh air if you feel nausea, headache, dizziness, or drowsiness.

999-000-23

**⚠ DANGER**

- CONTACT WITH A SPINNING PROPELLER WILL CAUSE SERIOUS INJURY OR DEATH.
- SHUT OFF ENGINES while people are in the water near the boat, on the swim platform, or on the boarding ladder.
- NEVER OPERATE IN REVERSE TOWARD A PERSON in the water.

999-000-03

**⚠ WARNING**

**Avoid serious injury or death from fire or explosion resulting from leaking fuel. Inspect system for leaks at least once a year.**

999-001-03

999-000-19

**⚠ WARNING**

Operating, servicing and maintaining a recreational marine vessel can expose you to chemicals including engine exhaust, carbon monoxide, antifeeders, and lead, which are known to the State of California to cause cancer and birth defects or other reproductive harm. To minimize exposure, avoid breathing exhaust, service your vessel in a well-ventilated area and wear gloves or wash your hands frequently when servicing this vessel. For more information go to [www.P65warnings.ca.gov/marine](http://www.P65warnings.ca.gov/marine)

YACHT CERTIFICATION

DESIGN COMPLIANCE WITH USCGA REQUIREMENTS IN EFFECT ON THE DATE OF CERTIFICATION IS VERIFIED. MANUFACTURER RESPONSIBLE FOR QUALITY CONTROL.

NATIONAL MARINE MANUFACTURING ASSOCIATION

THIS BOAT COMPLIES WITH U.S. COAST GUARD SAFETY STANDARDS IN EFFECT ON THE DATE OF CERTIFICATION

MEETS U.S. E/VP STANDARDS USING CERTIFIED COMPONENTS  
SEMINOLE MARINE, CAIRO, GA

CE	Seminole Marine Inc. CAIRO, GEORGIA U.S.A. 312CC
MAXIMUM	
C	10 ⚡ + III = 820 kg. MAX ⚡ 596.56 kW

**⚠ WARNING**

CONTENTS CAN BE UNDER PRESSURE

AVOID SERIOUS INJURY OR DEATH FROM FIRE OR EXPLOSION

OPEN SLOWLY IN WELL VENTILATED AREA, NO SMOKING OR OPEN FLAMES

(Inside Head Door)

**MEETS U.S. EPA EVAP STANDARDS USING CERTIFIED COMPONENTS**

SEMINOLE MARINE GROUP INC., CAIRO, GA

**⚠ WARNING**



Carbon monoxide (CO) can cause brain damage or death. Engine and generator exhaust contains odorless and colorless carbon monoxide gas. Signs of carbon monoxide poisoning include nausea, headache, dizziness, drowsiness, and lack of consciousness. Get fresh air if anyone shows signs of carbon monoxide poisoning. See Owner's Manual for information regarding carbon monoxide poisoning.

999-000-23

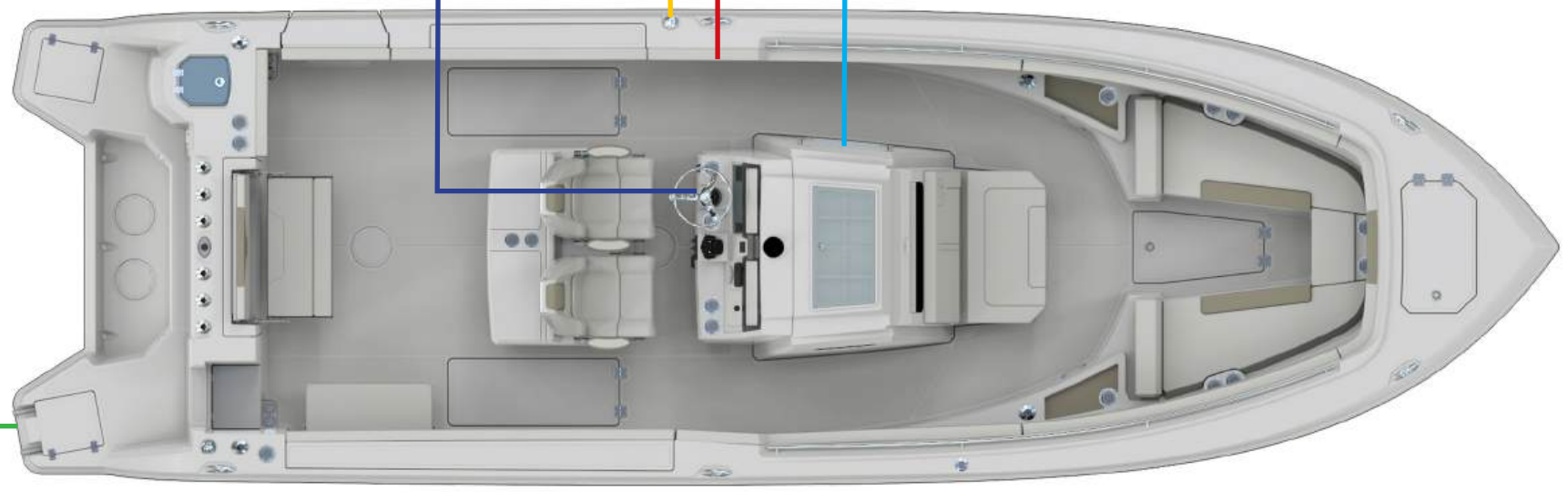



# SAILFISH 312 CC | OWNER'S MANUAL - WARNING LABELS & NAVIGATION LIGHTS

If any of your Boating Safety or Warning Labels become damaged, please call Sailfish Boats' parts department for replacement stickers at 229-377-2125.

Your vessel comes equipped with navigation lights that meet or exceed all Coast Guard Requirements.

Never modify navigation lights.

Additional lights should not be installed, as they could diminish the visibility of navigation lights or be confusing to other boaters.

Navigation Lights should be replaced when intensity becomes diminished or the lights fail.

For proper replacements, please call Sailfish Boats' parts department for replacement lights at 229-377-2125.



## THE SAILFISH PROMISE

Sailfish is committed to building **practical, purposeful, powerful boats** that deliver a premium boating experience without a premium price tag. Our customers and dealers know that our **build quality and safety are unsurpassed**, and our feature sets reflect intentional choices born of deep expertise. With our strong fishing heritage, we are **passionate about empowering anglers** for success while recognizing that those anglers deserve the **comfort, convenience and versatility to maximize their family's enjoyment** of the water.

## Unassisted Boarding Instruction

When using the ladder in an unassisted boarding situation, reach over the transom and open the covering board lid that is covering the ladder, pull ladder towards you, by picking up the ladder by the steps, release the strap, deploy the four step ladder by rotating it to the down position. Use your hand or foot to fully extend the ladder in the down position. Use the grab handle and ladder to board your boat. When fully onboard, be sure to place the ladder back in the storage position by reversing the deployment process.



# SAILFISH 312 CC | OWNER'S MANUAL - BATTERY SWITCH WIRING

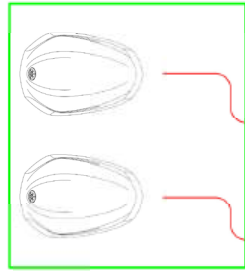

ITEM	DESCRIPTION
1	CONNECT TO "WINDLASS SOLENOID"
2	CONNECT TO "FWD BILGE"
3	CONNECT TO "AFT BILGE"

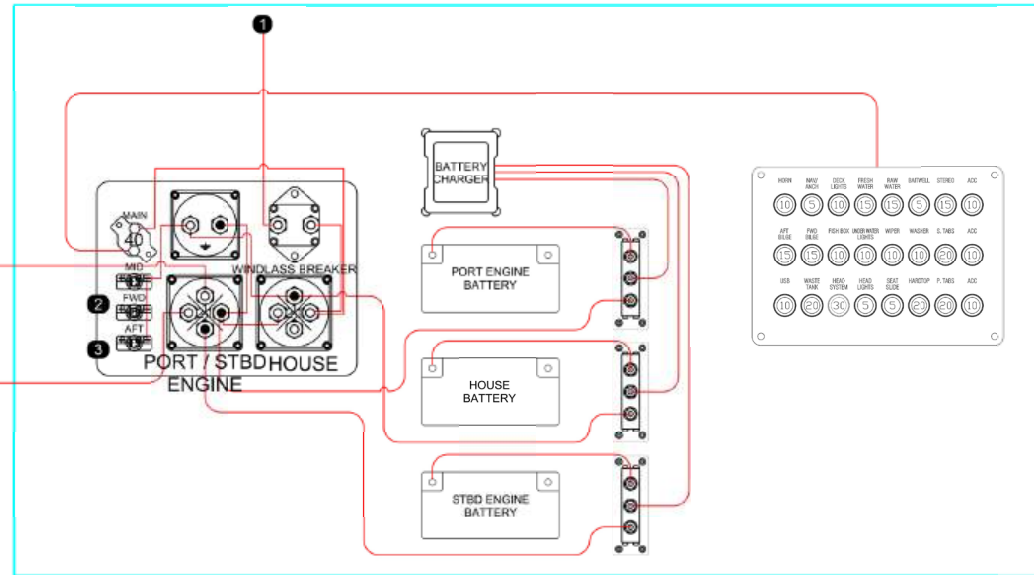

**Caution** – Be careful when recharging and disconnecting/reconnecting batteries.

When disconnecting the cables from the old battery, disconnect the negative first, then the positive. Connect the new battery in the reverse order, positive then negative.

**Caution** – Be careful when connecting/disconnecting shore supply power.

**Warning** – Do not swim close to a craft while connected to shore power.

[Download High Resolution Diagram](#)



# SAILFISH 312 CC | OWNER'S MANUAL - BREAKER PANEL SCHEMATIC

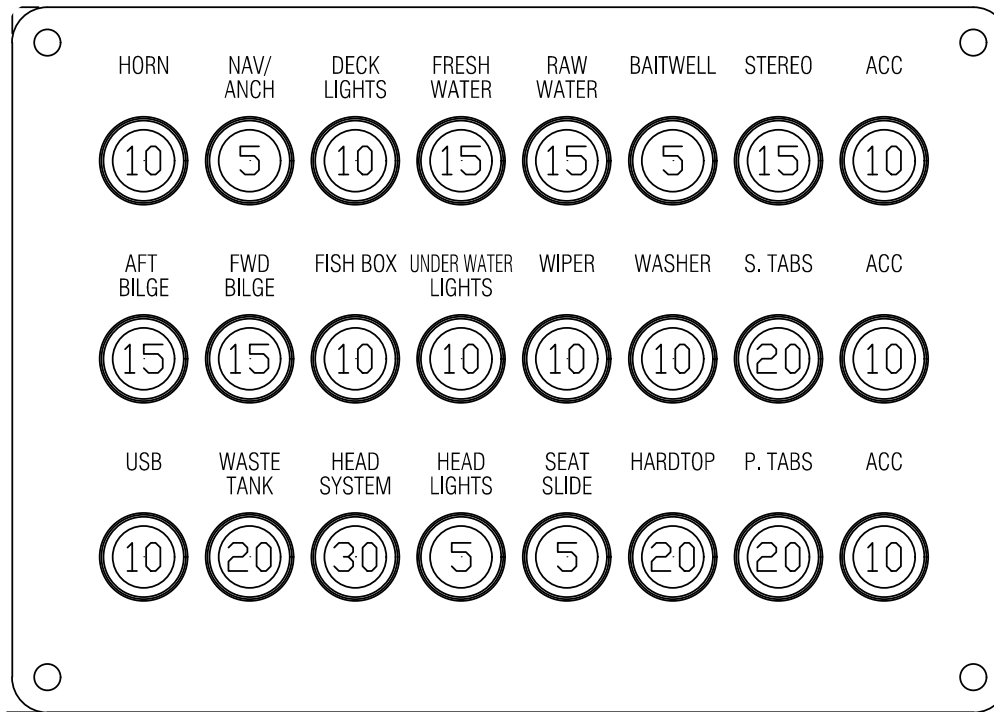

48	420-PPMSS8C312	8-32 X 5/16 SCREW W/EXT TOOTH
24	737-1300400	CB BOOTS
1	352-CLB30327W	30A CLB BREAKER
4	352-CBCKJ203	20A CMB BREAKER
5	352-CBCKJ153	15A CMB BREAKER
10	352-CBCKJ103	10A CMB BREAKER
4	352-CBCKJ053	5A CMB BREAKER
1	200-CS-07-0750	2 POS COPPER STRIP
1	200-CS-05-0750	5 POS COPPER STRIP
2	200-CS-08-0750	8 POS COPPER STRIP
1	202-02221-B	PIGTAIL
1	200-03183	FACEPLATE
QTY	P/N	DESCRIPTION
		CUSTOMER SEMINOLE
		MODEL 312CC
		PART NAME HELM CB PANEL
DRAWN BY JBR	DATE 7/12/22	
REVISED BY JBR	DATE 8/23/22	
FILE NAME 205-04529-B 312CC HELM CB PANEL.DWG	DWG NO. 205-04529	REV B

[Download High Resolution Diagram](#)





# SAILFISH 312 CC | OWNER'S MANUAL - SWITCH PANEL SCHEMATIC

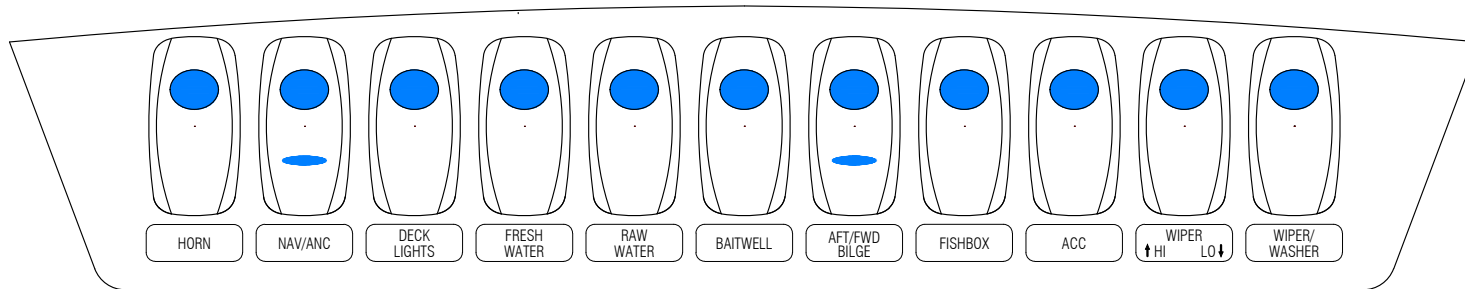

[Download High Resolution Diagram](#)

MATERIAL: 3/8 BLACK ACRYLIC 648-3752025

4	420-WFESS08X12	#8 FENDER WASHER
4	420-8EXTSTAR	8-32 NUT WITH EXT. LOCK WASHER
1	736-VXDJA60B	CONT SW SPDT OFF-1 ON-3 ON WIPER
1	736-VLD1S00B	CONT SW DPDT MOM ON-OFF-MOM ON WASHER
6	736-V1D1B60B	CONT SW SPST ON/OFF
2	736-VJD1G66B	CONT SW DPDT ON/OFF/ON - NAV/ANCH, BILGE PUMPS
1	736-V2D1B60B	CONT SW SPST MON - HORN
2	737-VVGWC00	ACT C5 2 LENSES NAV, BILGE
9	737-VVGVC00	ACT C5 BLUE OVAL LEN
1	605-2W210	1K OHM 2W RESISTER
1	204-00297-A	BLUE LED LIGHT
1	201-00855	LENS
1	202-02220-B	PIGTAIL
1	201-01010	FACEPLATE
QTY	P/N	DESCRIPTION
		CUSTOMER SEMINOLE
<small>100 Spells Rd Nashville, GA 31639 229-886-9589</small>		MODEL 312CC
		PART NAME HELM SWITCH PANEL
DRAWN BY JBR	DATE 6/24/22	
REVISED BY JBR	DATE 8/23/22	
FILE NAME 205-04528-B 312CC HELM SW PANEL 8-23-22.DWG	DWG NO. 205-04528	REV B



# SAILFISH 312 CC | OWNER'S MANUAL - FORWARD HULL HARNESS

A-14 BRN F BILGE 2 AUTO  
 B-14 BRN/WHT F BILGE 2 MAIN  
 C-14 BLK A BILGE 2

## F. BILGE PUMP

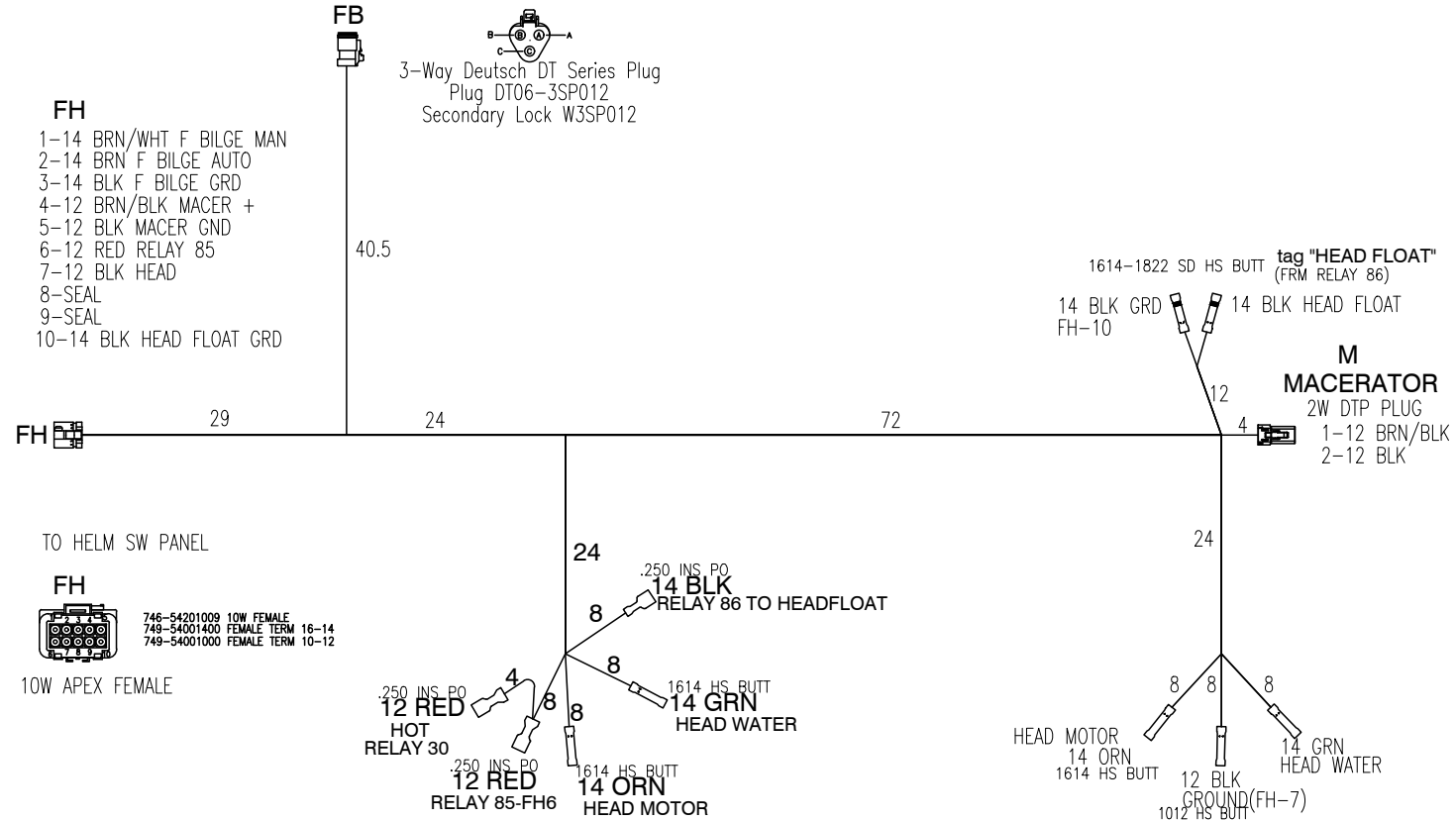

[Download High Resolution Diagram](#)



# SAILFISH 312 CC | OWNER'S MANUAL - AFT HULL HARNESS

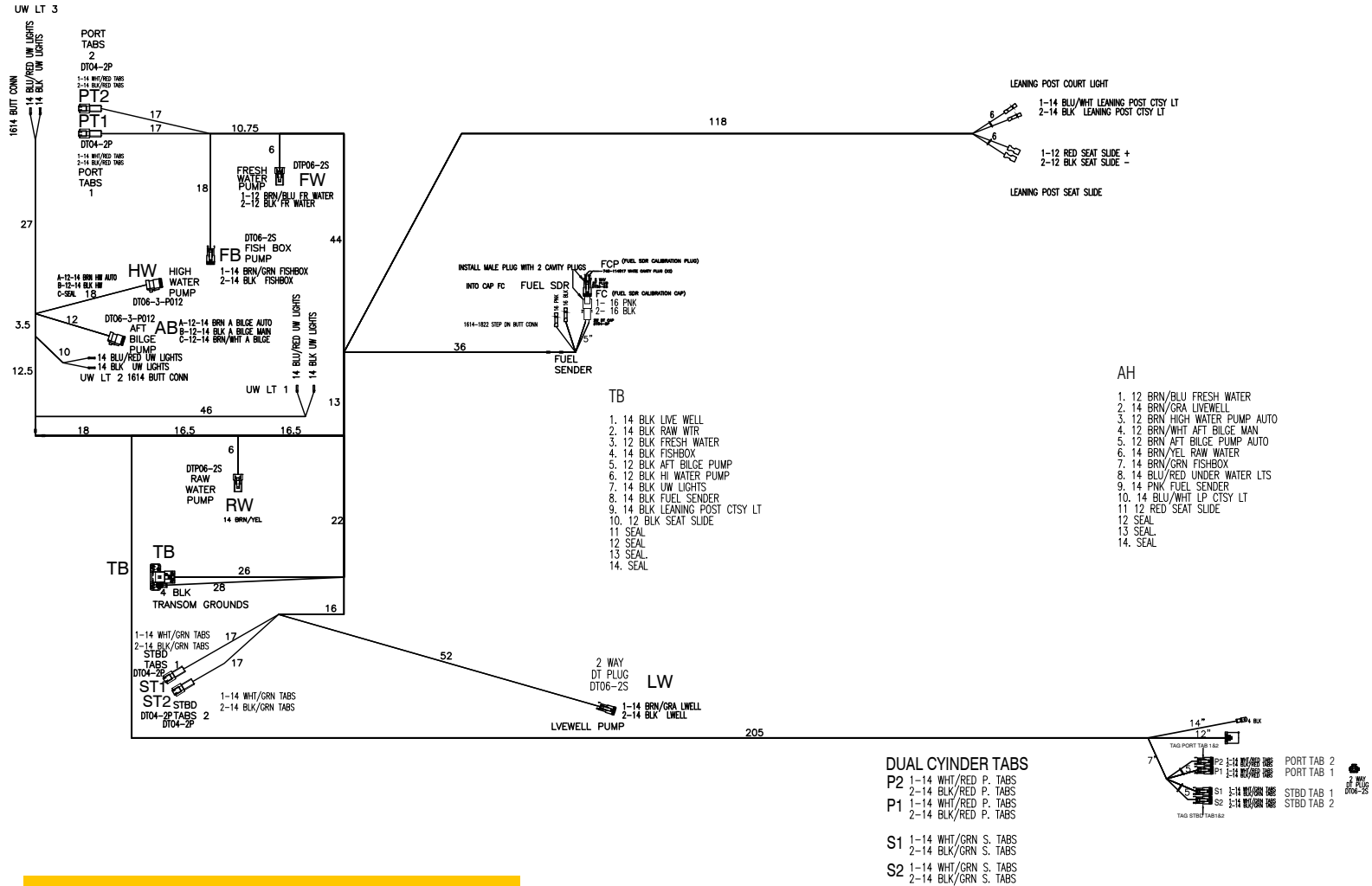

[Download High Resolution Diagram](#)

# SAILFISH 312 CC | OWNER'S MANUAL - DECK HARNESS



746-54001415 14 W MALE ASSEMBLY  
 749-54001401 MALE TERM 14-16  
 749-54001001 MALE TERM 10-12  
 745-54200005 CAVITY PLUG  
 REAR VIEW  
 14W APEX MALE

DH

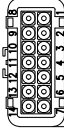

- |                     |                       |
|---------------------|-----------------------|
| 8-14 BLK COURT LTS  | 1-14 BLU/WHT COURT LT |
| 9-12 BLK USB        | 2-12 RED USB          |
| 10-SEAL             | 3-X                   |
| 11-14 COPPER S.A.   | 4-14 SILVER S.A.      |
| 12-14 COPPER S.P.F. | 5-14 SILVER S.P.F.    |
| 13-14 COPPER P.A.   | 6-14 SILVER P.A.      |
| 14-14 COPPER P.F.   | 7-14 SILVER P.F.      |

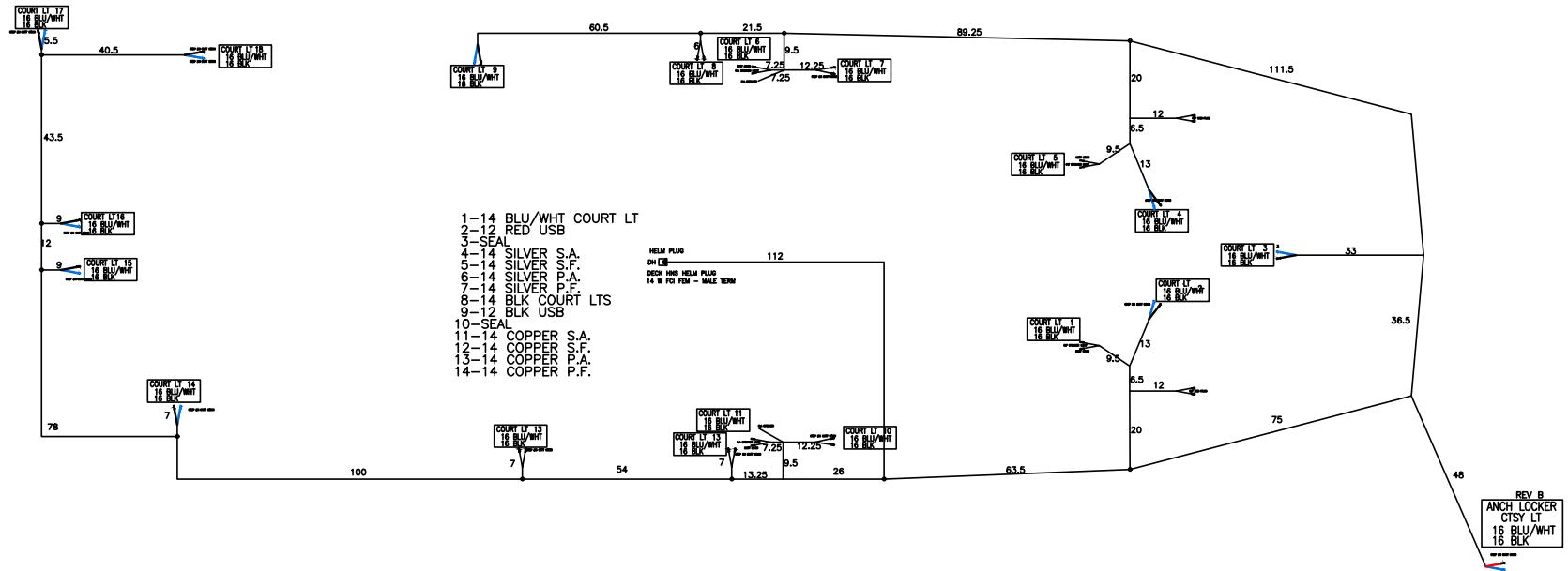

[Download High Resolution Diagram](#)

# SAILFISH 312 CC | OWNER'S MANUAL - HARDTOP HARNESS

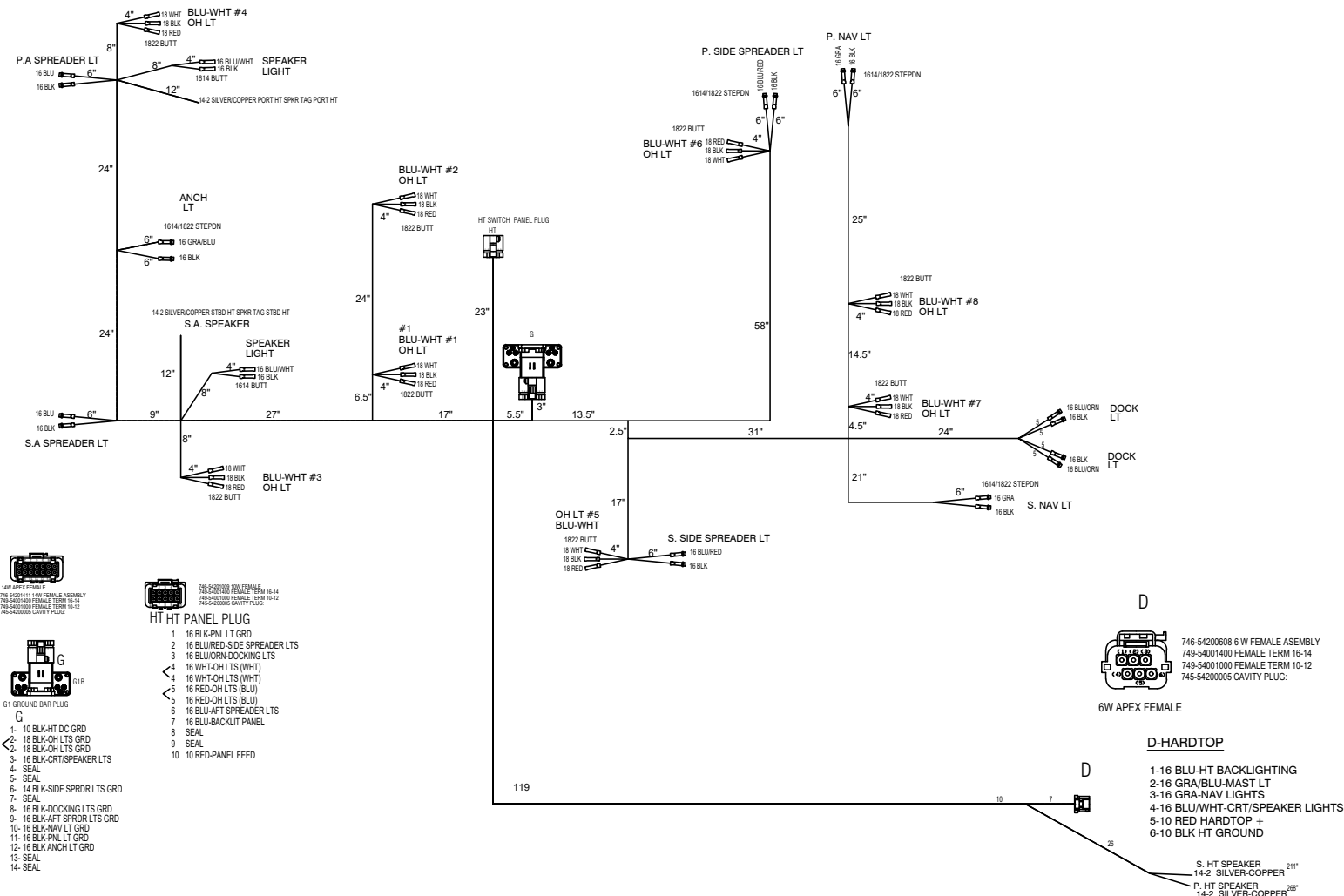

[Download High Resolution Diagram](#)



# SAILFISH 312 CC | OWNER'S MANUAL - FUEL SYSTEM LAYOUT



KEY	DESCRIPTION
1	Fuel Filter Access
2	Fuel Fill
3	Fuel Tank Location
4	Fuel Pickups
5	Fuel Sender



**Attention – A 20% reserve of fuel capacity should be kept for in case of emergency.**  
**Attention – The full capacity of tank may not be usable as a result of trim and loading of boat.**



# SAILFISH 312 CC | OWNER'S MANUAL - PLUMBING DIAGRAM

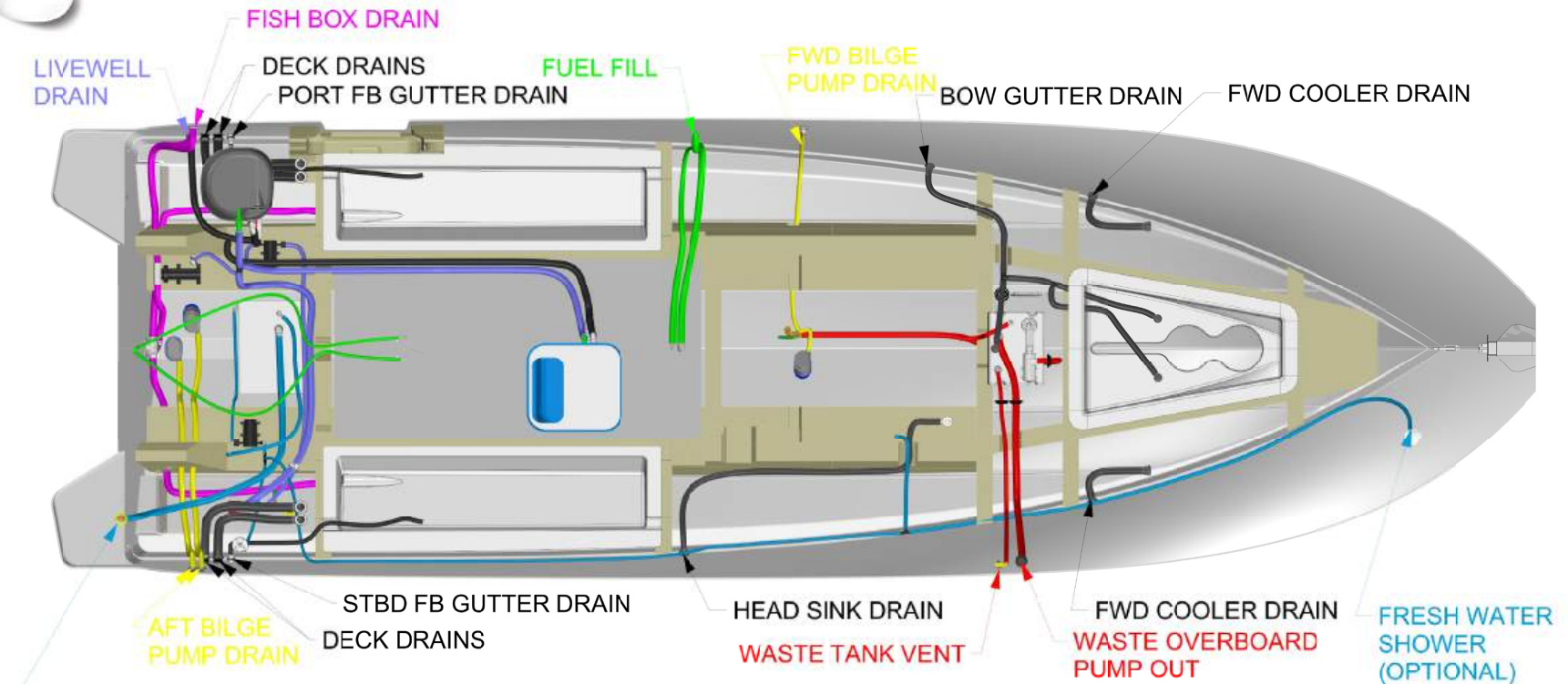

24

1. FISH BOX DRAINS
2. BILGE PUMP
3. FRESH WATER
4. DECK DRAIN
5. FUEL FILL
6. RAW WATER LIVEWELL
7. WASTE PLUMBING

[Download High Resolution Diagram](#)



# SAILFISH 312 CC | OWNER'S MANUAL - DASH LAYOUT

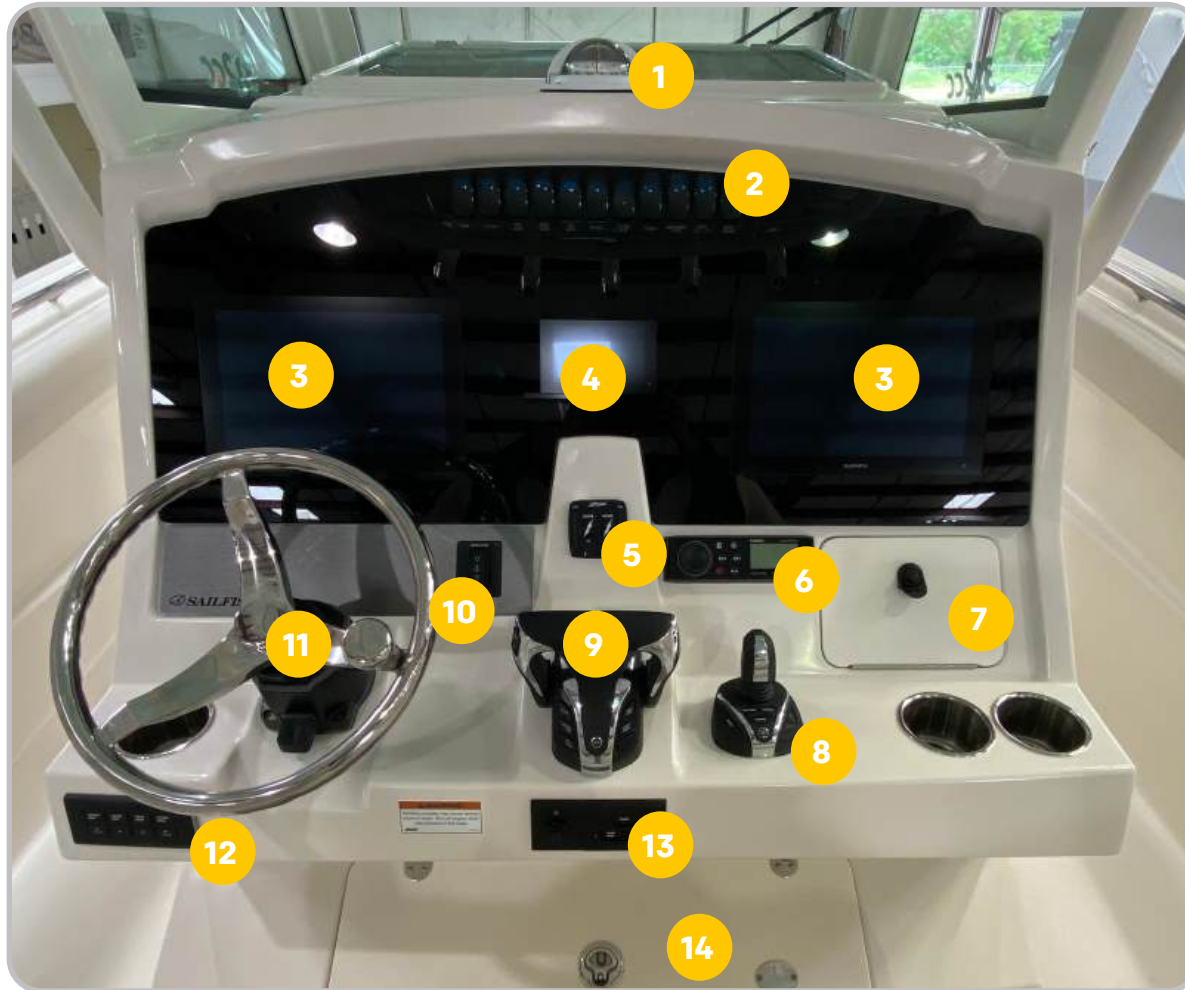

KEY	DESCRIPTION
1	Compass
2	Switch Panel
3	Optional Multi-Function Display
4	Brand Specific Motor Guages
5	Trim Tab Actuator Switches
6	Fusion Stereo
7	12 Volt Receptacle Inside Storage Pocket
8	Optional Engine Joystick
9	Binnacle
10	Windlass Controls
11	Tilt Helm
12	Optional Autopilot Control Pad
13	Ignition Switches
13	Emergency engine shut-off switch w/ lanyard
14	Footrest Console Storage

## Ignition Switches, Engine Shut-off Cord/Lanyard

Each Sailfish boat will be equipped with an ignition switch with an emergency engine shut off cord/lanyard.

This lanyard should be worn at all times while operating the vessel, if the vessel operator falls or moves a unsafe distance away from the helm controls the lanyard will pull out causing the engine to shut down.

Make sure the lanyard is not attached to a part of your clothing that could be easily torn free causing the switch not to pull. See your YAMAHA, MERCURY or SUZUKI owner's manual for more information on this safety feature.

## Engine Break-In Period

Each new outboard motor will need to go through a break in period to make sure all of the internal moving parts and components have a chance to correctly mate.

For more information on the break in period specific to your engine please refer to your YAMAHA, MERCURY or SUZUKI Owner's manual.



## Plug and Play Wiring

Deutsch Connectors are quick disconnect plugs used for durability and ease of replacing components in your Sailfish Boat.

These water resistant plugs are for use in electrical systems where moisture, salt spray, dirt and dust could affect the electrical connections or systems.

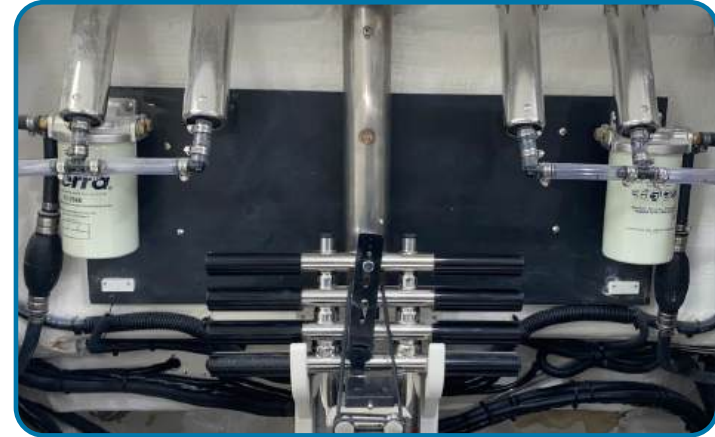

## Fuel-Water Separator

Sailfish installs water fuel separators in the bilge compartment on all models rigged with Yamaha & Suzuki engines. Each engine will have its own filter, which can be accessed through the bilge access doors in the back of the boat.

On Sailfish boats rigged with Mercury engine(s), the fuel-water separator(s) may be built into the engine - depending on the engine Model.

For more information on these filters, please review your Yamaha, Mercury or Suzuki Owner's Manuals.



# SAILFISH 312 CC | OWNER'S MANUAL - CONSOLE / HEAD AREA

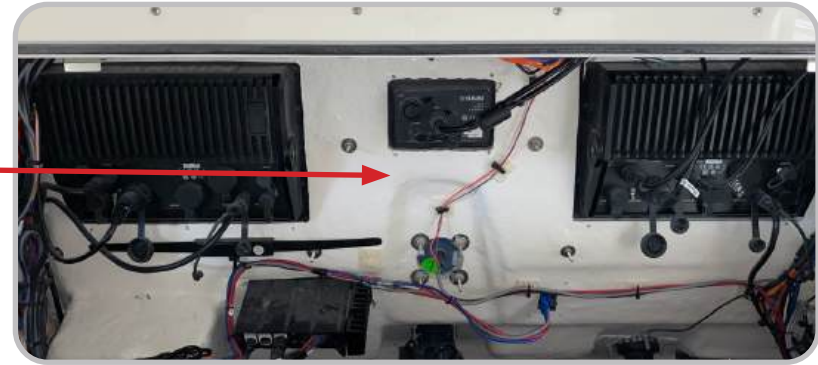

KEY	DESCRIPTION
1	Large panel for easy access to Console Components
2	Breaker Panel
3	Battery Selector Panel
4	Windlass Circuit Breaker
5	Light Switch
6	Battery Storage and Overboard Discharge Seacock & Forward Bilge Pump Access Hatch
7	Overboard Discharge Seacock



28





# SAILFISH 312 CC | OWNER'S MANUAL - HARDTOP LAYOUT

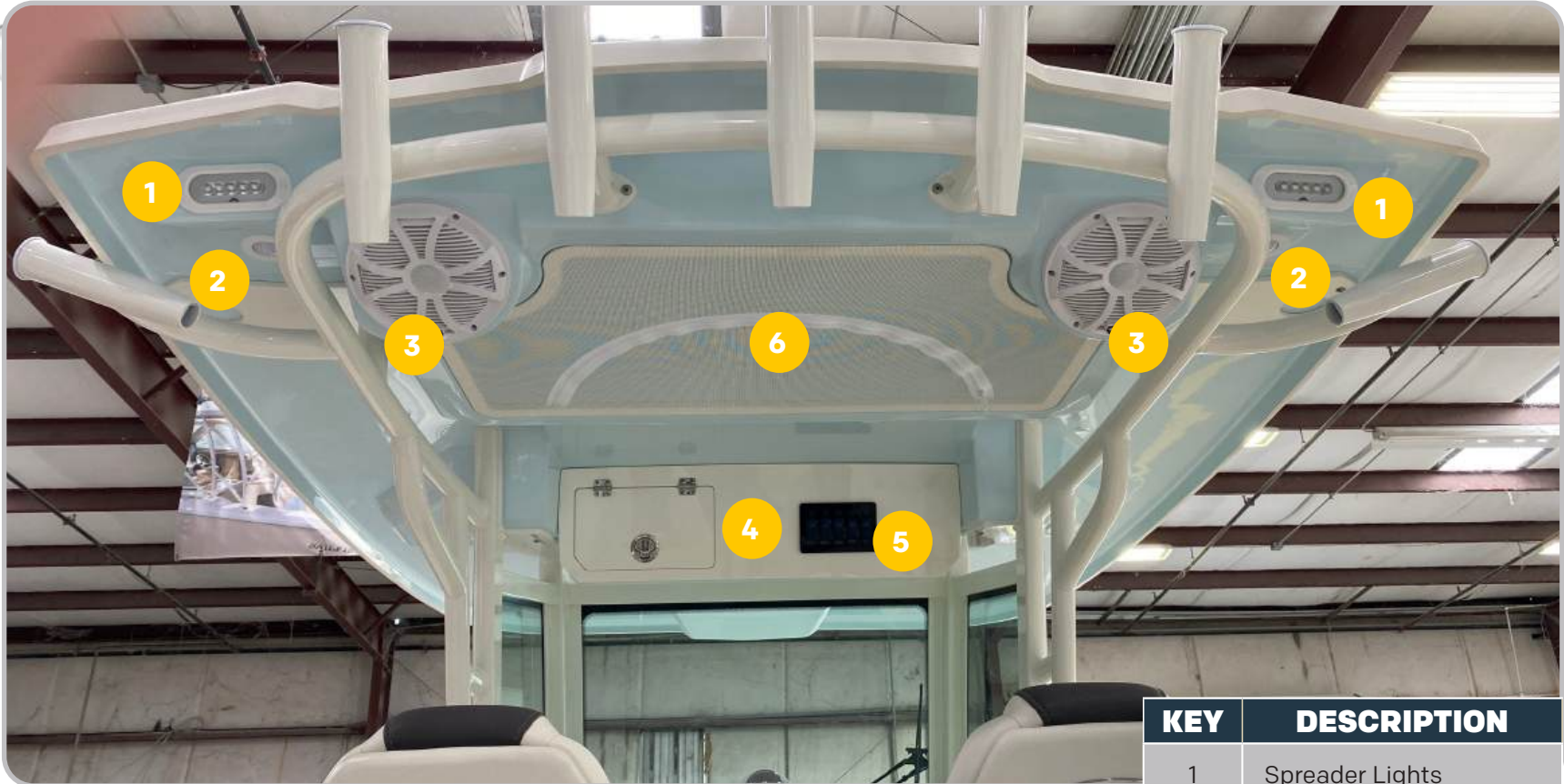

The standard hard top is equipped with courtesy lights, spreader lights, docking lights, an anchor light, two speakers, an overhead electronics panel and PFD Storage Area.

KEY	DESCRIPTION
1	Spreader Lights
2	Courtesy Lights
3	Speakers
4	Overhead Electronics Panel
5	Switch Panel
6	PFD Storage Area

# SAILFISH 312 CC | OWNER'S MANUAL - HARDTOP LAYOUT



30

The standard hard top is equipped with courtesy lights, spreader lights, docking lights, an anchor light, two speakers, an overhead electronics panel and PFD Storage Area.

KEY	DESCRIPTION
1	Docking Lights
2	Courtesy Lights

# SAILFISH 312 CC | OWNER'S MANUAL - VSR BATTERY SYSTEM

The VSR, or Voltage Sensitive Relay, is a very handy little box that solves a load of traditional charging problems on marine electrical systems. It essentially serves as a smart battery switch deciding automatically when either one or two batteries are charged – or discharged. It works great on almost any boat with multiple batteries – and eliminates all of the guesswork that used to come with manual battery switches.

## What a VSR does

The VSR is installed between two batteries. Many People are surprised to learn that it is NOT connected to either the alternator or charger output wires! Its setup is much more clever.

If either battery goes above 13.7 volts (due to either alternator or charger output), the VSR connects both batteries together. Both batteries are now charging – without the boat ever having to throw a switch.

Alternately, when the system voltage drops back below 12.6 volts, i.e., no more charging, the relay opens and the batteries are separate. This means that both batteries now discharge independently.

## How a VSR changes real world boating

Let's say that a fishing boat has a two battery setup. As is often the case, one of the batteries is dedicated to an important job – starting the engine. The other battery is used for other operations.

As the fisherman runs the boat from hole to hole, the engine alternator elevates the voltage to the cranking battery above 13.7 volts. This triggers the VSR to automatically connect the starting battery and house battery together. Both are now charging.

Upon reaching his destination, the boater kills the engine – and, the alternator output – and begins trolling. Because of the lowered voltage, the VSR now disconnects the batteries. Because he is now discharging only one battery, our fisherman is going to have starting power when he needs it later – no matter how long he uses the trolling motor and depletes that trolling battery. Once underway again, the alternator power causes the VSR to reconnect the batteries and begins replenishing the trolling battery.

Back home, the fisherman powers up his onboard battery charger, this increased voltage causes the VSR to once again link the batteries. This means that even a single output battery charger would now be charging both batteries!

31





## Bilge Access and Explanation

The bilge of your boat can be accessed through the large door in the aft of the boat. This large door allows easy access to many of the boats components.

You may also access it through the two access plates in the splash-well.

## Electronic Actuator

The Trunk can be actuated via the push button controls on the outside of the trunk.

**NOTE:** YOU MUST OPEN THE LATCH PRIOR TO USING THE ACTUATOR.

In the event of a power failure, the trunk can be opened manually, but must be supported externally, as the actuator will not hold the trunk without electrical power.



**The bilge area of your sailfish boat should be checked before, during and after each operation.**

# SAILFISH 312 CC | OWNER'S MANUAL - BILGE PUMPS

All Sailfish Boats are furnished with Auto-Sensing Bilge Pumps, which are engaged when the water level rises in the bilge and the causing the pump to turn on until the water level falls to a sufficient level.

These pumps can be tested by turning them upside down, the pump should turn on, once turned back over it will run for a few more seconds and then shut off. The pumps also have a manual switch function on the main switch panel which when engaged, will cause the pump to run until the switch is turned off.

The auto function of the pumps are wired into your boat bypassing the battery switch so that they have power at all times, this safety feature will counter water intrusion (up to the capacity of flow of the system) while you are away from the boat and the batteries are turned off.

The manual switch function is powered through the battery switch to prevent the pumps from remaining on accidentally by inadvertently leaving the switch on.

The Sailfish 312CC is equipped with two Aft - 2000GPH pumps and a midship - 800GPH pump.

Never leave your vessel unattended while in the water for long periods of time and always monitor your batteries voltage level and bilge water level.

**WARNING** — The bilge pumping system is not designed for damage control.

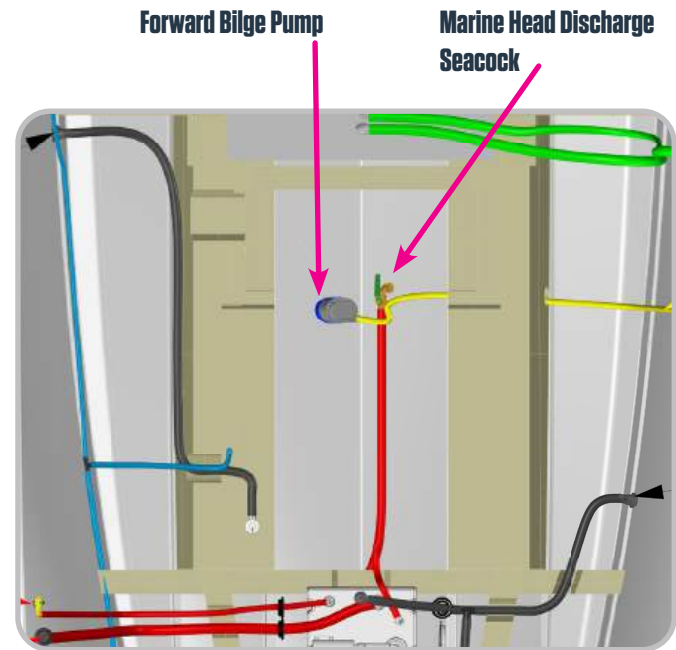



# SAILFISH 312 CC | OWNER'S MANUAL - RAW WATER WASHDOWN

The raw water washdown on your Sailfish Boat is powered by a Shur-flo Pro Blaster Pump which creates a pressurized system, once the pump is turned on and pressure is created the pump will shut down until more pressure is needed. The raw water washdown pump can be accessed through the bilge access door in the aft of the boat.

To operate make sure the seacock is in the open position. The hose fitting for the washdown is located in the transom splash well, to use simply attach a hose with a nozzle and turn the switch on. Pressure will build up in the hose and the nozzle and as you spray the pump will continue to engage as needed.

**THIS PUMP HAS A BUILT-IN STRAINER THAT MUST BE CHECKED AND CLEANED REGULARLY TO MAINTAIN PROPER FUNCTION.**



## Transom Walkthrough Step Seacock Access Hatch



# SAILFISH 312 CC | OWNER'S MANUAL - FRESHWATER WASHDOWN & SHOWER

The freshwater washdown and shower system on your Sailfish Boat is powered by a Shur-flo Pro Blaster Pump which creates a pressurized system, once the pump is turned on and pressure is created throughout the freshwater hoses; once they are all pressurized the pump will shut down until more pressure is needed.

**THIS PUMP HAS A BUILT-IN STRAINER THAT MUST BE CHECKED AND CLEANED REGULARLY TO MAINTAIN PROPER FUNCTION.**

All of the freshwater systems on the boat will operate on this system once the freshwater switch is engaged.

You should allow a few seconds for the system to prime and pressurize before attempting to use any of the showers/sinks ect.

The freshwater holding tank is located behind the fuel tank in the bilge area.

The fill for this tank is located under the boarding ladder on the starboard side of the vessel. The freshwater pump can be accessed through the bilge access door in the aft of the vessel.



35



Optional Bow Shower



# SAILFISH 312 CC | OWNER'S MANUAL - LIVEWELL OPERATION

## Instructions

- Make sure the seacock below the baitwell pump is in the open position (seacock is accessed through the hatch under the transom walk thru door).
- Turn on the livewell switch.
- Adjust the black aerator in the livewell to the desired flow (if your model has a livewell in the leaning post you can adjust the aerator to pump water into the transom livewell or the leaning post livewell or both).
- In order to fill the livewell, reach in the access hatch below the livewell and close the red handle ball valve. The leaning post livewell ball valve can be accessed in the hatch at the bottom front of the leaning post.
- The livewell will fill up until it reaches the Overflow built into the side of the livewell. This allows the water to continually pump in and drain out while maintaining the water level.
- To drain the livewell open the red handle ball valve.

### Transom Access Hatch



### Aerator



### Leaning Post Access Hatch

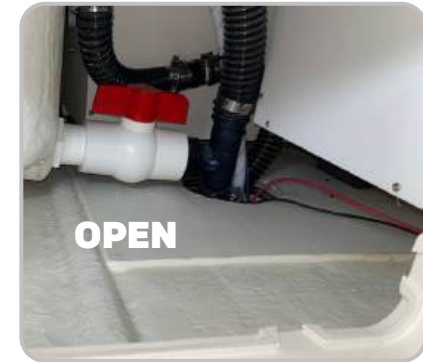

### Transom Walkthrough Step Seacock Access Hatch





# SAILFISH 312 CC | OWNER'S MANUAL - FISHBOX PUMP

The 312 CC is equipped with a diaphragm pump called the gulper grouper. (pictured top right). The Whale Gulper Grouper pump has no impeller to clog or burn out. Unlike impeller pumps these have no-choke valves that easily pump out fish box waste. They also offer long term durability, they can run dry without causing damage.

This pump will pump both fish boxes through a system called a flooded T (pictured bottom right) The flooded T allows both boxes to have a centralized drainage location that can be operated by a single pump.

## Troubleshooting

Electric Motor Runs but doesn't pump:

- Disconnect pump and turn off all power.
- Disconnect hoses and unscrew housings.
- Check entire hose system for blockage.
- Inspect tricuspid valves for blockage or inverted valve(s).
- If valve(s) are blocked, remove blockage, re-assemble the pump and continue use.
- If a tricuspid valve is inverted, replace with a new tricuspid valve, reassemble the pump and continue use.

If the electric motor will not operate, check that:

- The isolator switch is on.
- There is 12 volts at the battery terminals.
- The in-line fuse / circuit breaker are operational.

If the fuse / circuit breaker has blown, check for debris in pump head and clean out if necessary. Replace the fuse or re-set circuit breaker and run the pump.



# SAILFISH 312 CC | OWNER'S MANUAL - OPTIONAL RETRACTABLE SKI TOW PYLON



1. Catch fingers under the top of the ski tow bar and pull up.
2. After pulling up to use the tow bar, turn to the left to lock the tow pole in the UP position by finding and listening to the catch bar secure in place.
3. To lower the tow bar, turn to the right for it to release and lower gently into place. DO NOT drop it.

Use caution when raising and lowering the ski bar. Ski tow bar is heavy and can cause harm to fingers.

**MAX WEIGHT LIMIT – 1,500 / 681 kg**



38



**WARNING - NOT TO BE USED TO TOW BOATS, JET SKIS, INFLATABLES OR SUCH. Designed ONLY for use for water sport activities.**



# SAILFISH 312 CC | OWNER'S MANUAL - BENNETT TRIM TAB MAINTENANCE

## ELECTRICAL CONNECTIONS

- Periodically, check for clean electrical connections on all components.

## COLD TEMPERATURES

- Cold temperatures do not affect the trim tab system. No winterization is necessary.

## SACRIFICIAL ANODES

- To deter electrolysis, a sacrificial anode should be attached to the top of each trim tab. The anode must make direct contact with the stainless steel trim tab. Do not paint the anode. Do not ground trim tabs to other underwater appendages.

## PAINT TRIM TABS TO DISCOURAGE MARINE GROWTH

1. Clean surface of all grease, oil, dirt.
  2. Apply two coats of epoxy metal primer.
  3. Apply two coats of anti-fouling paint. Actuator, including the piston, may be painted.
- Unpainted trim tabs may acquire an orange discoloration. THIS OXIDATION OF SURFACE CARBON MOLECULES IS NORMAL. The integrity of the stainless steel is not affected. Orange coating can be cleaned off, but may eventually return. NOTE: This discoloration should not be confused with the pitting and corrosion of electrolysis.

## MAINTENANCE PRECAUTIONS

- Take immediate action to correct any malfunction or failure of your trim tabs.
- Occasionally, check for loose or corroded wiring connections.
- Stepping on the trim tab may cause damage to the unit, or injury.
- Leaving the actuator extended when boat is not in use will NOT cause seal damage.

## OPERATION PRECAUTIONS

- Do not over-trim, particularly at high speeds as the bow will dig in and wave action may cause the boat to veer.
- While underway, do not move one trim tab significantly farther down than the other as undesirable listing could occur.
- Use your trim tab helm control with caution.
- For best maneuverability, trim tabs should be fully retracted in a following sea, or when running an inlet.
- Improper use of trim tabs can cause an accident or injury. Bennett Trim Tabs have a significant effect on the operation and versatility of your boat. No one knows your boat better than you. The best learning method is to spend time getting familiar with your boat's reaction to the trim tabs. As your experience with Bennett Trim Tabs increases, so will your enjoyment. Always operate your boat with safety first in mind.



# SAILFISH 312 CC | OWNER'S MANUAL - WINDLASS

Your boat has a factory installed windlass and there will be a complete owners' manual in your owners packet. For more detailed information please refer to your windlass owners manual.

Included on this page are some maintenance recommendations and a troubleshooting guide.

## Maintenance

### General Recommendations

- After the first two or three anchor recoveries, check the mounting nuts to ensure that the windlass is still fastened tightly to your deck, as it should now be bedded-in.
- Regularly wash down the exterior of your windlass with fresh water.
- Examine all electrical connections for possible corrosion, clean and lightly grease as necessary.
- Anchor rode splice should be checked regularly and remade if there is any evidence of wear.
- The Gypsy should be examined on a regular basis, because it is a high wear item. The Gypsy is designed for short scopes of chain and will last longer if properly used.



The windlass breaker is located on the battery switch panel located behind the dash in the head/console compartment.

## Troubleshooting

### Anchor Rode pays out independently while windlass is not in use

This problem is a result of not securing the anchor rode combined with the Gypsy Drive Cap being slack. Tighten the Gypsy Drive Cap using the tool provided and always secure the anchor rode independently of the windlass whenever it is not being deployed or recovered.

### Electrical Troubleshooting

As with most electrical marine equipment the majority of problems that arise are electrical in nature. Therefore it is essential that the proper voltage be maintained. The proper voltage on a 12 Volt system is 13.5 Volts. (Constant low voltage will destroy the motor). Ensure that electrical cable size is large enough to handle the current draw imposed upon it and keep the voltage drop within acceptable limits. In any circumstance voltage drop due entirely to cable resistance should not exceed 10%.

Follow the charts on the following page to troubleshoot the problem.

<b>Failure to Operate Troubleshoot Chart: Reversing Toggle Control Switch (Part No. 0052519)</b>	
Is there voltage at the input terminal (positive) to the control switch?	If no voltage is present, the battery isolation is OFF, the breaker is tripped or a fuse has blown. The battery may also have been dead or disconnected.
<b>Yes ▼ No ►</b>	
Check voltage at the output terminals of the control switch with the switch on forward then reverse.	Control switch is defective.
<b>Yes ▼ No ►</b>	
Replace Motor	
<b>Sluggish Operation Troubleshoot Chart</b>	
Is windlass overloaded?	Ease the load and ensure the battery is well charged.
<b>Yes ▼ No ►</b>	
Check the voltage across the motor leads with the windlass on. (Proper voltage is 13.5V. Constant low voltage will destroy the motor).  Is the voltage low? (Below 11.0V on a 12V system?)	There is a severe voltage drop in the circuit.  Check for undersized cables, poor connections or corroded connections. Also check for resistance across the battery isolation switch or solenoid. (Feel them to see if they are heating up).
<b>Yes ▼ No ►</b>	
Is the voltage correct? (Above 11.0V and anchor is not fouled).	The motor is defective. Replace the motor.
<b>Yes ▼ No ►</b>	

## SAILFISH 312 CC | OWNER'S MANUAL - UFLEX POWER ASSISTED STEERING



42

Standard on Twin Suzuki 300/350HP engines, MasterDrive™ is a power assisted steering system operated by an electrohydraulic pump which delivers fingertip control regardless of speed or torque conditions, ensuring full control of the boat both during maneuvers and in bad sea conditions.

The MasterDrive™ is made up of three main components: helm, power unit and user interface. The user interface, which is located on the boat dashboard, allows the boater to select three different power modes according to the sailing conditions:

- Fishing
- Cruise
- MasterDrive™

# SAILFISH 312 CC | OWNER'S MANUAL - YAMAHA ELECTRIC STEERING

Helm Master EX offers boaters customizable, integrated boat control with more ease and convenience than ever before.

**Yamaha's Digital Electronic Steering (DES)** is the electronically controlled steering system is the Industry-first integrated electric steer-by-wire system. Unlike aftermarket steering systems, it is digitally connected from the helm to the engine. It offers stable and assured steering and also steering setting can be changed depending on various boating situations.

For more information on the use of your Yamaha Helm Master EX steering system please refer to your Yamaha owner's manual or view supplemental videos at <https://yamahaoutboards.com/owner-center/videos/helm-master-ex/>

**Optional Equipment shown: Joystick & Autopilot.**





## SAILFISH 312 CC | OWNER'S MANUAL - OPTIONAL OPTIMUS JOYSTICK (SUZUKI ONLY)



The Dometic Optimus 360 Joystick Control brings a whole new level of precision to your boat's steering. This intuitive, retrofittable joystick allows you to move not only forward and back, but also sideways. With additional features including a sensitive touch function and Take Command mode, the Optimus 360 lets you direct and rotate your boat with confidence and control.

Optimus 360 is designed for low speed maneuvering, and really excels in the marina, when pulling in and out of your slip, or docking. Optimus 360 uses intelligent programming to minimize the amount of shifting required to complete a maneuver.

44



## Electric Advantage

With no hydraulics, you get more space in the utility compartment of your boat and a cleaner transom installation. Electric Steering also minimizes noise and distraction – a meaningful benefit for Joystick Piloting for Outboards (JPO) applications, when the engines are actively holding the boat in position or maneuvering the vessel.

## Exceptional Control

Enjoy instantly responsive handling and precise, smooth maneuvers.

**Standard on V10 Verado, Optional on V8 Verado Configurations.**



# SAILFISH 312 CC | OWNER'S MANUAL - OPTIONAL MERCURY JOYSTICK (JPO)

## Full 360 degree control. Right at your fingertips

Move sideways, diagonally or spin the boat on its own axis. Dock in close quarters without being concerned about wind or current. Easily load the boat on a trailer. Throttle, shift and steering - right at your fingertips.

## SKYHOOK Digital Anchor

A digital anchor that locks in your boat's position and heading via GPS with the push of a button.



VesselView 502



# SAILFISH 312 CC | OWNER'S MANUAL - CONSOLE TOP ORGANIZER ("CTO")

The console top organizer is a great place to store almost anything. It also includes a dual USB charging receptacle.

Always store the organizer with the lid closed and the spring positioned as it is in the picture to the right.

When possible, store covered out of sunlight to avoid UV damage to the lid.



47

KEY	DESCRIPTION
1	Lid Spring
2	Dual USB Charging Receptacle

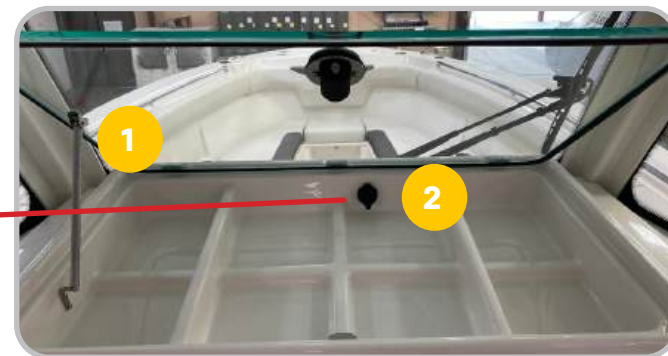
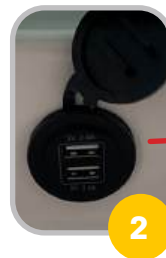



# SAILFISH 312 CC | OWNER'S MANUAL - TYPE III MSD WASTE MANAGEMENT SYSTEM

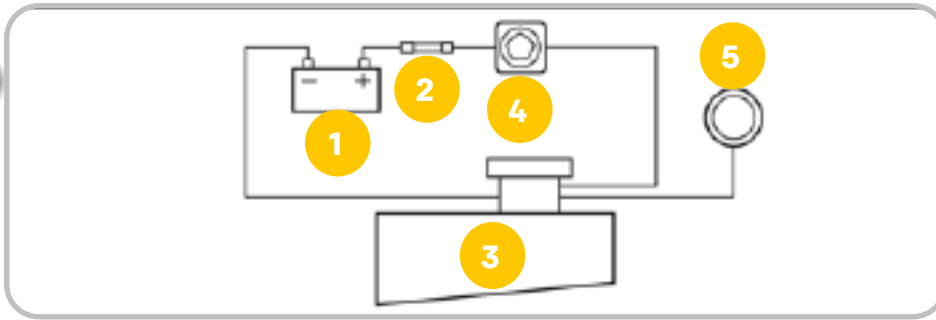

KEY	DESCRIPTION
1	Battery
2	Fuse
3	Waste Management System
4	Master Switch
5	Controller for Waste Management System

KEY	DESCRIPTION
1	Vent
2	Inlet
3	Toilet
4	Deck Pump Out
5	Overboard Dis-charge
6	Waste Holding Tank
7	Outlet

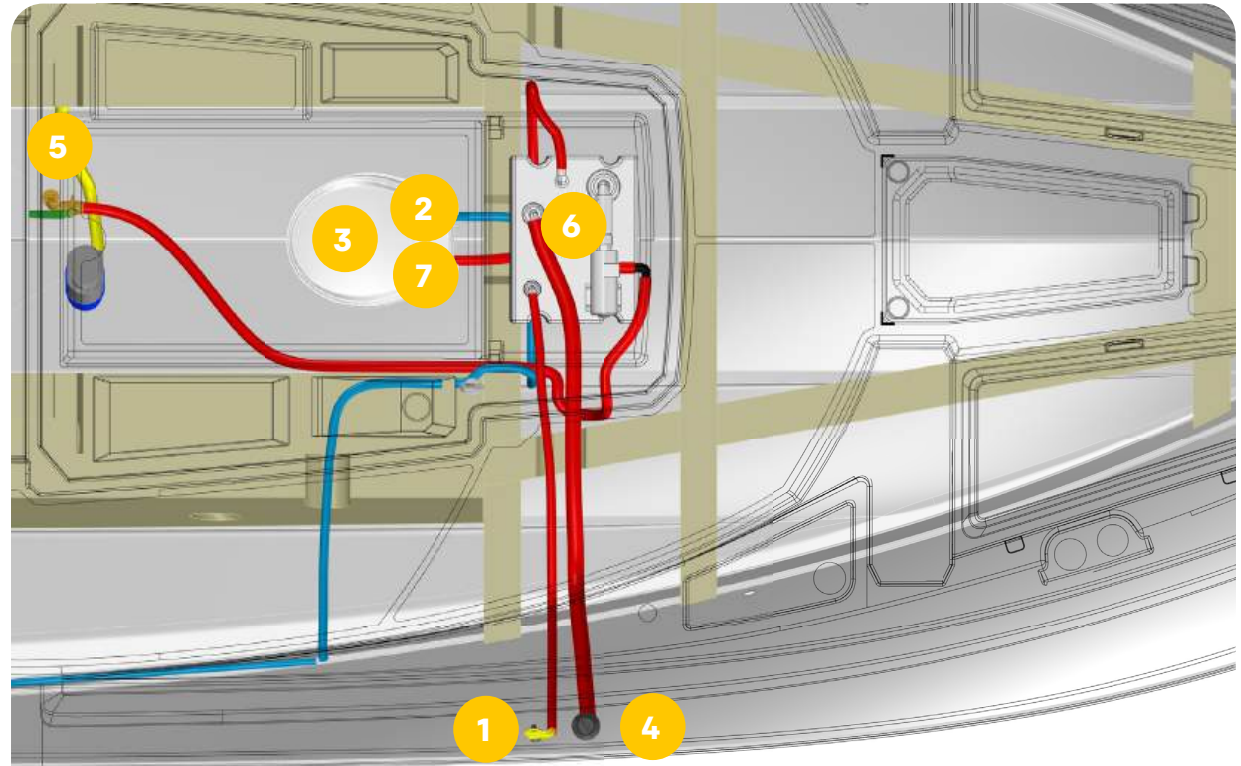

**Attention – Do not discharge toilets or holding tanks close to shore or in any prohibited zone, and use harbor or marina pump-out facilities to empty the holding tank before leaving the harbor.**

SAILFISH 312 CC | OWNER'S MANUAL - TYPE III MSD WASTE MANAGEMENT SYSTEM



## Dometic Flush Toggle Switch

**Freshwater Flush** (toilet with DFST switch)

### Toilet system start-up

1. Turn on fresh water supply to toilet.
2. Press “Flush” switch (2) and hold for at least 10 seconds.
3. Toss several sheets of toilet paper into bowl and repeat cycle. The bowl should completely clear.

### Normal toilet operation

#### ADDING WATER TO TOILET BOWL

Press “Add Water” switch (1) and hold until desired water level is achieved. (Do not press “Add Water” switch too long or overflow may occur.)

#### FLUSHING TOILET

Press “Flush” switch (2) down and hold until waste drains from toilet bowl (about 10 – 20 seconds). This switch activates a macerator pump that siphons water and waste from the bowl, macerates, and propels the effluent to the discharge line/holding tank. To use less water for liquid-only flushes, press “Flush” switch for shorter period of time.

#### “DRY BOWL” OPERATION

During periods of rough travel, water in a toilet bowl can splash out and into the bathroom area. To avoid this situation, press “Dry Bowl” switch (3) to drain water completely from toilet bowl. Water is not added to bowl during or after pressing the “Dry Bowl” switch.



**Caution: Do not operate toilet without water supply turned on. Damage to internal components may occur.**

## Full Tank Monitor

- Your vessel is equipped with a waste tank level monitor and shut down relay which will disconnect power from the toilet when the waste tank becomes full. This is intended to prevent damage from flushing waste while the holding tank is already full.
- Pump out the waste holding tank to allow the marine head to reset the system and allow the marine head to flush again.
- When the waste holding tank is full, the LED Indicator shown below will light up.



Standard Dometic Tank Monitor



All Toilets are equipped with a “Full-tank” shut-down relay.



## DOMETIC OVERBOARD DISCHARGE

In addition to the Type III Waste System described previously, boats equipped with the overboard discharge option have the ability to manually pump waste tank contents directly overboard in unrestricted waters. (Consult Local and Federal Laws)

When Tank Monitor indicates "FULL" holding tank, follow the below steps to discharge contents.

1. Rotate Sea Cock to Open Position (Fitting and Handle are in-line)
2. Insert key into switch and turn to momentary "START" position. Allow key to return to "ON" position. (Green light indicates pump is running.)
3. When complete, the discharge pump will turn off automatically, and the Tank Monitor will indicate "EMPTY".
4. Turn key to left "OFF" position and remove from switch.
5. Return Sea Cock to Closed position. (Fitting and Handle are 90 deg offset.)

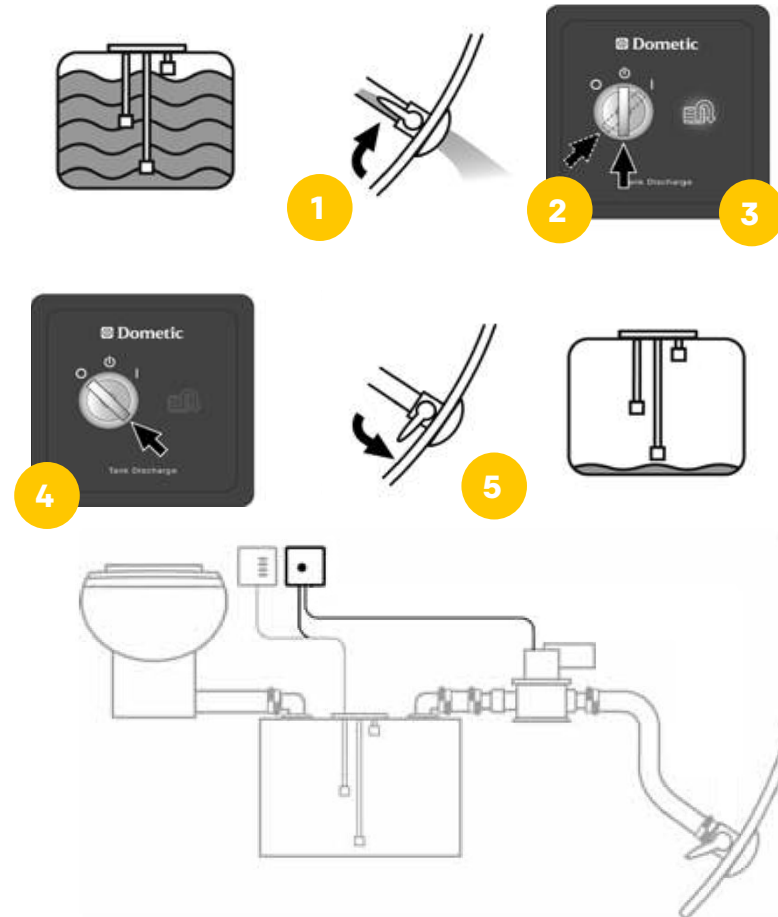

NOTE: When tank is not above "MID" Level, the pump will only run as long as key is held in momentary "START" position.



All Toilets are equipped with a "Full-tank" shut-down relay.

## Maintenance & Winterizing

### Cleaning the toilet

To maintain the toilet's original, lustrous appearance, use Dometic® Toilet Bowl Cleaner or other non-abrasive bathroom and toilet bowl cleaners. Please follow label directions.



#### Caution

To avoid damaging internal seals, do not clean toilet with abrasive cleaners, caustic chemicals, or lubricants and cleaners that contain alcohols or petroleum distillates.

### Routine maintenance

#### MONTHLY

1. Inspect toilet, plumbing, and plumbing connections, wires, and wire connections.
2. Open and close all plumbing valves, including seacocks.
3. Check in-line water filters and vented loops for blockage.

#### YEARLY

Check water valve filter. Also check water valve filter if water flow into toilet becomes insufficient.

### During extended periods of non-use

The macerator toilet and sanitation hoses should be protected if toilet will not be needed for an extended period of time (more than two weeks, especially in hot weather).

1. Flush toilet and add 4 oz. (118 ml) of liquid biodegradable laundry detergent (should NOT contain bleach or environmentally harmful substances). Note: If using sea water for flushing, shut off power to sea water pump and add fresh water directly into the bowl during the flush cycle.
2. Flush toilet at least five times.
3. Turn off water supply to toilet.
4. Flush the toilet without water very briefly to evacuate all water. (This procedure will minimize any remaining water in the macerator pump.)



#### Caution

During water evacuation process, do not operate sea water pump very long without water. Pump impeller may become damaged.

5. Turn off power to the toilet.
6. After extended periods of non-use, toilet and pump may dry. For easier re-start of toilet system, add one quart of water to bowl and let it stand for a few minutes before use.



#### Caution – Do Not Flush Foreign Objects!

Flush only water, bodily wastes and rapid-dissolving toilet tissue. Do not flush wet wipes, sanitary napkins, condoms, diapers, paper cups, cotton swabs, food, hair or liquids such as oils or solvents as clogging or damage to the toilet or toilet system may occur.



#### Note

Make sure all guests understand toilet operation before use.

## Maintenance & Winterizing

At the end of each season, the Dometic macerator toilet should be winterized for storage by using potable water-safe antifreeze (if boat or vehicle will be exposed to freezing temperatures).

If system will be subjected to freezing temperatures, please follow procedures in section 7.3, "During extended periods of non-use", and then winterize system as described here.



### Note

Use nontoxic antifreeze designated for potable water systems. (See boat or vehicle owner's manual.)



### Caution

Never use automotive-type antifreeze in freshwater systems.

### PRESSURIZED FRESH WATER SYSTEM

1. Drain potable water tank and empty holding tank.
2. Add freshwater antifreeze to potable water tank.
3. Flush potable water antifreeze and water mixture through toilet(s) and into entire system, including the waste holding tank, diverter valve connections, discharge pumps, etc. Turn off power to toilet.

Each installation is different, so amounts may vary. User discretion is required to assure adequate protection.

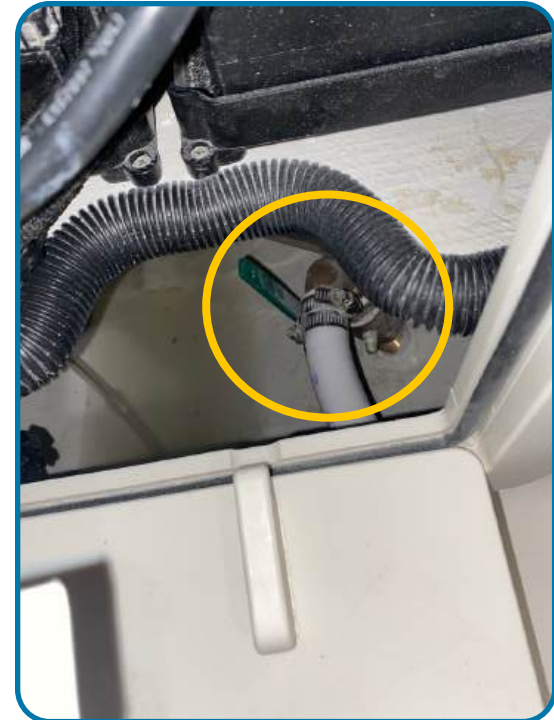

54

Access to the Marine Head Discharge Seacock is located in the Fwd head area accessed through the battery storage compartment hatch.

NOTE: This is a freshwater marine head system that runs off the boats freshwater tank, using the head will effect the boats freshwater supply.

## TROUBLESHOOTING

Problem	Possible Cause	Service Instruction
1. Flush function works, but water in bowl empties slowly or not at all.	<ul style="list-style-type: none"> <li>a. Discharge piping is pinched or kinked.</li> <li>b. Discharge piping is too high. (Remember, all upward vertical loops and should not exceed a total of 4 feet (1.2 m) in height.)</li> <li>c. The macerator pump or discharge piping is blocked.</li> </ul>	<ul style="list-style-type: none"> <li>a. Check discharge piping.</li> <li>b. Reroute discharge piping.</li> <li>c. Close seacocks and clear blockage.</li> </ul>
2. Macerator pump makes unusually loud noise or continually trips breaker.	<ul style="list-style-type: none"> <li>a. Foreign material in pump chamber.</li> </ul>	<ul style="list-style-type: none"> <li>a. Close seacocks and clear foreign material.</li> </ul>
3. Flush cycle is not activated after pushing on flush switch.	<ul style="list-style-type: none"> <li>a. Holding tank is full and signal from tank has shut down electrical power to toilet.</li> <li>b. Electrical power to toilet is shut off or disrupted.</li> <li>c. Flush switch is malfunctioning.</li> </ul>	<ul style="list-style-type: none"> <li>a. Empty holding tank.</li> <li>b. Check wiring and circuit breakers (or fuses).</li> <li>c. Replace flush switch.</li> </ul>
4. Insufficient or no water enters the bowl.	<ul style="list-style-type: none"> <li>a. Water supply line is pinched or kinked.</li> <li>b. Screen in water valve is blocked.</li> <li>c. Intake water filters are blocked (in sea water system).</li> <li>d. Water valve is malfunctioning.</li> </ul>	<ul style="list-style-type: none"> <li>a. Check water supply line.</li> <li>b. Clear blockage at water valve.</li> <li>c. Clear water filters.</li> <li>d. Replace water valve.</li> </ul>



## DOs

### Reactive & Preventative Cleaning

- Clean the material immediately if it comes in contact with substances like grease, blood, sauces, lipstick, wine, or coffee to prevent permanent stains and/or build-up.
- Clean at least once a week to extend the lifespan of the upholstery. This prevents dirt and other contaminants from building up and stains from becoming permanent. If there is a spill, wipe off any excess right away with a dry cloth, making sure not to spread it all over the surface.
- Clean the whole surface in circular motions using liquid hand soap (pH neutral) and water (1 part soap : 9 parts water). Wipe with a clean damp cloth to get rid of any excess soap. Repeat as needed and then let dry. Check the Spradling website for a complete list of approved cleaners. (<https://spradling.group/en-us/products/simtex?reference=Plata>)
- If there is any build-up that can't be removed with soapy water, then use this as a last resort. Mix 1 part isopropyl alcohol to 1 part water. (Using alcohol on a regular basis can affect the properties of the product.)
- Once a month, use a soft bristle brush for a deeper cleaning. Lighter colors need more care, more often.

## DON'Ts

### Techniques never to use

- Solvents like paint thinner, varsol, acetone, whiteners, waxes, silicones, detergents, and/or cleaning products that are not pH neutral.
- Products that are more than 50% alcohol.
- Never make marks on the product with pens or markers as it may absorb the ink and stain permanently.
- Cleaning tools like plastic or wire sponges, or hard-bristle brushes that can damage the material permanently.

56

## Remember

- It is important to note that this guide is not a warranty. It has recommendations for properly using and cleaning our upholstery products. Users are responsible for using and cleaning the coated fabrics safely with products that don't affect the surface, composition, or, as a result, their performance and lifespan.
- Cleaning results may vary depending on the size of the stain, cleaning product used, and time the surface is exposed.

The information provided is designed to give you a thorough understanding of the factors that can impact the appearance of your anodized aluminum. By using this information, we hope to help you enhance the beauty and value of our products.

## What Causes It?

Corrosion is a natural phenomenon that affects metals by either a chemical or electrochemical reaction. The rate at which aluminum corrodes depends greatly on the environmental conditions and the amount of preventative

maintenance performed. Our goal is to slow down or stop this natural phenomenon we call pitting (or corrosion).

## Anodized Aluminum

The aluminum on your boat has been anodized. This creates a very hard protective seal on the surface of the aluminum to protect it as much as possible from pitting. When the anodized coating is broken and raw aluminum is exposed, corrosion will take place. Damage from other abrasive impacts can break the anodized coating.

## Chemical Attack

Corrosive chemicals containing high concentrations of acids or alkalis will remove the anodized coating. Solutions containing chlorine, salts, or ammonia are all harmful to the anodized aluminum on your boat. Many common household cleaners contain chemicals that will remove the anodizing and cause pitting.

AVOIDABLE	UNAVOIDABLE
Strong acidic solutions found in cleaners, paint remover, degreasers, etc.	Airborne pollution. Airborne particles from local sources: vehicles, incinerators, paper mills, chemical plants, power plants, etc.
Concentrated alkaline based solutions. Many concentrated soaps fall into this category.	Harsh chemicals from work performed at local shipyards and dry docks.
Chlorine, sulfurs, solvents and ammonia based products.	Be aware of local sources that can expose your new boat to corrosive chemicals.



## Tips

Avoid the use of bleach or chlorides to clean the aluminum or nearby components. Chlorides can leach onto the aluminum when used nearby.

Avoid abrasive cleaning products. Never use steel or brass wool, wire brushes, polishing wheels, rubbing or polishing compounds. These items will remove the anodizing and lead to pitting.

## Protective Products

There are many different products available to protect aluminum. Some are designed to seal and protect before problems occur and others are designed to use after pitting has appeared.

While these products are effective, they are not one time solutions. Metal protectors must be reapplied on a regular basis. How often a protector should be used varies according to the protector you choose, the types of exposure your

boat is subjected to, and how often you use and wash your boat. Follow the application guidelines provided with the protector you choose.

## Harmful Cleaners

Bleach (Chlorox, etc.)

Mild abrasive cleaners (Ajax, Comet, Soft Scrub, Rubbing Compounds, etc.)

Strong cleaners (409, Engine Degreasers, Bilge Cleaners, Teak Cleaners, Bottom Cleaners, etc.)



### Below are some metal protection products that are readily available at marine retailers.

Woody Wax CPR	Woody Wax woody-wax.com 800-619-4363
Boeshield T-9	PMS Products, Inc. boeshield.com 800-962-1732
Premier Polish	Aquatech aquatech-marine.com 800-853-7760
Corrosion Block	Lear Chemical learchem.com 800-256-2548

The information provided is designed to give you a thorough understanding of the factors that can impact the appearance of your stainless steel. By using this information, we hope to help you enhance the beauty and value to our products.

## What Makes Stainless Steel Stainless?

Oxygen is the key element in causing rust, or red oxide on steel and other metals. Stainless Steel contains Chromium which reacts with the oxygen in the air to form a chrome-oxide surface layer that is invisible to the eye, but strong enough to prevent further oxygen from "staining" (rusting) the surface. Higher levels of Chromium and the addition of other alloying elements such as nickel and molybdenum enhance this surface layer and improve the corrosion resistance of the stainless material.

## What Determines Different Grades of Stainless Steel?

The grade of Stainless Steel is primarily determined by the amount of the Chromium and Nickel alloys contained in the material. 304 and 316 are the prominent grades of Stainless Steel: 304 contains 1% Chromium and 8% Nickel, while 316 Contains 16% Chromium and 10% Nickel and 2% Molybdenum. The Molybdenum is added to help resist corrosion to chlorides (like sea water and de-icing salts).

## Can Stainless Steel rust?

Not in the way steel rusts. Steel will discolor, bubble and flake from red oxide development. Stainless Steel may develop red spots, but this is usually due to Iron particles on the surface of the Stainless Steel. Any Iron particles must be removed and the Stainless Steel cleaned with a high concentration of citric acid or a commercial cleaner specifically designed for Stainless Steel.

## Is Stainless Steel Green (Environmentally Friendly)?

Stainless Steel is highly sought after by recyclers and is 100% recyclable. New Stainless Steel typically has a recycled content of between 65% & 80% which makes it one of the highest average content recycled construction materials on the planet.

## Will Stainless Steel Discolor?

Cleaners that are typically used with cement, grout and stone, etc., may contain Muriatic Acid. Stainless Steel is not resistant to Muratic Acid. MURIATIC ACID SHOULD NOT BE USED IF STAINLESS STEEL IS PRESENT. It is not even necessary that the acid touch the Stainless Steel, just the "fumes" from it will cause a discoloration of the Stainless Steel. Other than this, Stainless Steel is usually very resistant to discoloring.



# SAILFISH 312 CC | OWNER'S MANUAL - WINDSHIELD WASHING AND CARE

1. If you have been offshore, be sure to spray the windshield liberally with a hose to melt and wash away any salt crystals.
2. Use commercially available glass cleaners or a mixture of fresh water and vinegar. Do not use abrasives, harsh chemicals, or metal scrapers. Regular cleaning will help assure clarity of the glass for safe boating.
3. The Windshield Washer Fluid Reservoir is located inside the console footrest.





## SEAKEEPER RIDE MAINTENANCE SCHEDULE

System / Component	Task	Interval	Parts / Special Tools
Mechanical / Corrosion	Inspect/replace sacrificial anode.	6 Months or 500 Hours	Sacrificial Anode Part Number: Zinc-12833SP Aluminum-12909SP 750-1500 Anodes (Per controller)-13771
Mechanical / Fasteners	Check Seal Plate bolts are still at torque spec for 450, 525, 600 or 750-1500	3 Months or 250 Hours	Torque wrench
Actuator Friction	Check Actuator is held tightly in place by Seal Plate.	3 Months or 250 Hours	
Electrical / Connectors	Inspect all connectors for corrosion, replace if necessary.	12 Months or 1000 Hours	
Electrical / Grounds	Inspect all ground points for corrosion, clean as necessary, and treat with corrosion inhibitor.	12 Months or 1000 Hours	
Electrical / Cables	Check all cables and wire harness branches for cracks or chafing.	12 Months or 1000 Hours	

<https://manuals.seakeeper.com/ride/seakeeper-ride-maintenance/3-maintencance/maintenance-introduction/>

## Your Boat's Gel Coat Finish

Congratulations! You are the proud owner of a new Sailfish. You are also the owner of a new gel coat finish on the hull and/or topside, and we would like you to be as proud of it as we are. That beautiful, shiny new color you love is the result of many years of gel coat research, testing and development.

But as proud as we are of the gel coat, no finish is totally impervious to chemicals and weathering. Imagine what a brand new car could look like if allowed to sit at a marina for years with no cover and no washing or waxing. With the same minimum maintenance you would ordinarily give your new automobile's finish, your boat's gel coat finish will retain its depth of color and gloss for years.

## Overall Maintenance

Normal maintenance of your gel coated fiberglass boat is similar to the care you would give your automobile. Overall, automotive cleaners and waxes work fine, as well as the marine cleaners and waxes.

Note: Do not use caustic or highly

alkaline (high pH) cleaners or those containing ammonia. These type of cleaners may darken white or off-white weathered gel coat surfaces. A chemical reaction producing staining occurs if these type of cleaners are used on weathered gel coat. However, the stain may be removed with a rubbing compound or by lightly sanding with 400 grit sandpaper followed by an application of rubbing compound and a thorough waxing.

## Cleaning

We recommend general washing to avoid soil build-up and staining. The soil to your gel coat is the result of regular use and environmental pollutants such as soot and smog. Periodic cleaning with a mild detergent is necessary to remove normal deposits of soil.

## Waxing

From constant exposure over time to our natural environment and undesired pollutants, the gel coat begins to lose its gloss. To restore your finish to the original gloss and color requires your special attention. After washing with a mild soap or detergent, give the surface a good polishing with a self-cleaning marine or automotive wax. Waxing in the fall

and spring is generally recommended to maintain and restore most of the original gloss. If the surface has not been maintained and has weathered badly, and if cleaning and waxing does not restore the finish satisfactorily, compounding will be required.

## Compounding

Please see your marine dealer for advice. Polishing and compound (fine abrasive) or rubbing compound (coarser abrasive) is recommended for use on fiberglass boats to remove scratches, stains, or a severely weathered surface. Polishing or rubbing compound can be applied by hand or by pneumatic buffer. After the scratched, stained or weathered surface has been removed, it should be waxed to enhance the gloss and color while providing a seal to retard staining or new soil accumulation.

## Discoloration Removal

Your marine dealer is best equipped and trained to do this work. If regular washing and waxing has been neglected, discoloration of the gel coated fiberglass surface may occur.

Discolored areas are very shallow in depth, literally right on the surface. The discoloration may be removed by gently wet-sanding the affected areas only by using 600 grit, wet or dry specially treated waterproof sandpaper. It's important to always sand in one direction, this includes the curves too. Use plenty of water to cool and clean the sandpaper and cut back on dust. After you are finished sanding, dry the areas and verify all the discoloration has been removed. If not, repeat the process.

After all the discoloration has been removed, the area will need to be buffed. Using an electrical or pneumatic buffer, buff at low speed (1750 rpm – 2250 rpm), this will restore the luster to the sanded surface. Using a generous amount of rubbing compound, apply it in a circular motion with a soft wool pad. When buffing has been completed, wash off the rubbing compound with clean water, and dry the surface.

To restore the gloss to the affected area, use a high-grade marine or automotive wax.

## Repairs

During the life of your boat, some damage to the gel coat surface is unavoidable. We recommend repairs done by trained, experienced professionals at your local marine dealer.

## Scratches

If the scratch is in the gel coat surface, not penetrating the fiberglass, use an automotive polishing compound and rub it out. Apply the compound by hand using a damp rag or by using a power buffer. The scratch may not entirely disappear, but it should be noticeably better.

## Gouges and Chips

Our recommended patching procedure is to first clean the area needing repair with an acetone solvent to remove all traces of wax and oil. Next, thoroughly mix one tablespoon of "Patch Paste" with two or three drops of catalyst on a scrap piece of cardboard.

Apply the mixture to the pit, chip or gouge with a single-edge razor blade, matching the surface and contour of

the area being repaired. Apply slightly more mixture to avoid having to fill the damaged section a second time. Allow the patch to harden thoroughly for a minimum of two to three hours.

Using a fine grit "wet or dry" sandpaper on a sanding block, wet-sand the patch until it is level with the surrounding surface. Finish with a marine or automotive rubbing compound using the same approach as used for the scratches.

## Refinishing

For a severely scratched or weathered fiberglass boat that is no longer restorable by using the previous methods, it may then be necessary to refinish it with two-package or two-part aliphatic urethane enamel. This can be done very effectively, but it is recommended refinishing should only be done by experienced professionals.



# SAILFISH 312 CC | SAILFISH BOATS LIMITED WARRANTY

SEMINOLE MARINE INC. ("Sailfish" producer of Sailfish Boats warrants to you, the first retail purchaser of a new boat bought from a factory authorized dealer, that it will repair or replace defects in materials or workmanship that occur and are reported to your factory authorized dealer within the applicable Warranty Periods set forth below, subject to the terms, conditions and exclusions ("What This Warranty Does NOT Cover") set forth below. Your acceptance of delivery of the warranted boat constitutes your acceptance of the terms of this limited warranty. All warranty periods run from the date (the "Effective Date") of delivery to the original retail owner (the "Owner"), or twelve (12) months from the date the boat was delivered to the Sailfish dealer, whichever is earlier. This limited warranty applies only to covered defects first arising and reported to Sailfish or its authorized dealer within the applicable warranty coverage period.

U.S. purchasers: this warranty gives you specific legal rights, and you may also have other rights which vary from state to state. E.C. purchasers: the owner has legal rights under applicable national legislation and the Consumers Protective Directive 1999/44/EC of the European Parliament and of the Council of 25 May 1999 governing the sale of consumer goods, and those rights are not affected by this limited warranty. Any claim that the boat was nonconforming at the time of delivery must be made within two (2) years from the date of delivery.

## **WHAT THIS WARRANTY COVERS:**

**Structural Warranty:** Structural fiberglass defects in workmanship and materials in the hull, stringers, transom causing the boat to be unfit for general use as a pleasure craft under normal conditions of operation - Limited Original Purchaser's Ten (10) years.

**Component Warranty:** For defects in workmanship and materials in factory manufactured and installed non-structural parts and components - One (1) year Limited Warranty.

The applicable Warranty Period runs from the date of delivery of the boat to the first retail customer, and warranty coverage applies only to warranted claims that first arise and are reported to Sailfish within the applicable warranty period. This warranty extends only to the first retail purchaser.

The express limited warranty described above is the sole and exclusive express warranty from Sailfish. **Under the laws of certain states, there may be no implied warranties or conditions from Sailfish applicable to your boat, and all implied warranties (INCLUDING ANY IMPLIED WARRANTY OF MERCHANTABILITY OR FITNESS FOR A PARTICULAR PURPOSE) and conditions are excluded and disclaimed from warranty coverage where allowed by law. Any IMPLIED WARRANTIES (if any) arising under applicable law are LIMITED IN THEIR DURATION TO TWO (2) YEARS FROM THE EFFECTIVE DATE.**

ALL IMPLIED WARRANTIES, if any, INCLUDING **MERCHANTABILITY or FITNESS FOR A PARTICULAR PURPOSE ARE EXCLUDED AND DISCLAIMED** IN THEIR ENTIRETY AFTER TWO (2) YEARS FROM THE EFFECTIVE DATE. There are no warranties which extend beyond the description on the face hereof. **Some states do not allow limitations on how long an implied warranty lasts, so the above limitation may not apply to you.**

## **WHAT THIS WARRANTY DOES NOT COVER:**

Sailfish does not provide any warranty coverage, nor have any liability or responsibility, for any defects, costs, expenses or damages relating to the following:

- The failure to use, maintain or store the boat as specified in the manuals supplied to the Owner;
- A boat purchased from anyone other than an authorized dealer;
- A boat, including its components, that has been altered, modified or not properly maintained;
- A boat, including components and systems, that has been altered or modified from factory specifications; equipment and accessories not factory installed by Sailfish;
- Engines, outdrives, controls, propellers, batteries, generators, appliances, air conditioners, stereos and other equipment or accessories that are not manufactured by Sailfish, whether or not warranted by other manufacturers. It is the owner's obligation to fulfill any warranty registration and other obligations as to any third-party manufacturer's warranty coverage, and to submit any warranty claims directly to the third-party warrantor. Note: it is the Owner's responsibility to complete any OEM warranty registration procedure that may be applicable;
- Non-structural parts and components manufactured or installed by third parties, whether or not warranted by other manufacturers;
- The cost of removal or reinstallation of parts or disassembly of units to repair or replace components covered by this limited warranty;



# SAILFISH 312 CC | SAILFISH BOATS LIMITED WARRANTY

- Any boat which has been in an accident, misused, used in a negligent manner, used for racing, used for rental, charter, demo, military, rescue, fire, safety, medical, police, law enforcement, patrol, or other governmental or commercial purposes, operated contrary to any instruction furnished by Sailfish, or operated in violation of any governmental or agency laws, rules or regulations;
- Fiberglass blistering attributable to water penetration of the fiberglass (osmotic blistering);
- Any representation relating to speed, range, fuel consumption or other estimated performance characteristic;
- Loss of time, inconvenience, boat payments, retail charges, improper lifting or trailering, travel expenses, loss of use, in-and-out-of-water charges, towing and storage charges, loss of or damage to personal property, or other remedies not specifically allowed;
- Damage from osmosis blistering if the original gel surface has been altered in any way;
- Damage or deterioration of cosmetic surface finishes, including corrosion, cracking, crazing, discoloration, fading, rusting or oxidation of gel coat and painted fiberglass surfaces, wood finishes (varnishes, stains and paints), fabrics, plated or painted/powder coated metal and stainless steel finishes; anti-fouling bottom paint or zinc anodes;
- The cost to remove, disassemble or reinstall components not installed by Sailfish that require removal to access parts covered by this limited warranty;
- Dealer preparation, cleaning, final adjustments and alignments in preparing the boat for delivery or commissioning;
- Normal and routine maintenance and wear and tear, including leakage around windshield, hatches, canvas, or other designated openings;
- Window glass and windshield damage, leaks or breakage; damage, shrinkage or deterioration of carpet, upholstery, and exterior canvas tops, enclosures, and weather covers;
- Fit and adjustment of exterior canvas tops, enclosures and weather covers;
- Sacrificial deterioration of anti-fouling paint or zinc anodes; or
- Cosmetic and/or damage resulting from normal wear and tear, or improper care and maintenance, either by dealer prior to consumer purchase or by consumer are not covered.

## **REMEDIES AND OTHER INFORMATION:**

Your **sole and exclusive remedy** (including any applicable implied warranty) is the repair or replacement, at Sailfish sole option, of parts and components covered by this warranty, **and does not include incidental or consequential damages which are specifically DISCLAIMED and EXCLUDED from warranty coverage**. U.S. purchasers: some states do not allow the exclusion or limitation of incidental or consequential damages, so the above limitation or exclusion may not apply to you. Any legal action alleging a breach of warranty must be brought within one (1) year from the date the alleged breach first occurred, regardless of the time remaining in the applicable warranty period. The boat, including any alleged defective part, must be returned to an authorized dealer (or as otherwise directed by Sailfish) within the applicable warranty period to obtain warranty service. The authorized dealer will carry out the warranty procedures on the owner's behalf. All warranty work will be performed at an authorized dealer, another repair facility that Sailfish selects, or the factory, at Sailfish' option. The owner is responsible for the expense associated with transporting the boat to and from the repair facility.

This document contains the entire warranty given by Sailfish and there are no terms, promises, conditions or warranties regarding your Sailfish other than those contained herein. Sailfish reserves the right to change Sailfish specifications, features, and prices without prior notification and without obligation for Sailfish previously manufactured.

Your acceptance of delivery of the warranted Sailfish constitutes your acceptance of the terms of this limited warranty. Your Sailfish dealer is an independent business and is not the agent of Sailfish. Your Sailfish dealer may not modify or change the terms of this limited warranty, and any questions concerning the scope of this limited warranty coverage should be addressed directly to Sailfish. Neither your Sailfish dealer nor anyone else is authorized to extend the time or scope of this warranty, or to create or assume for Sailfish any other obligation or liability with respect to Sailfish or this warranty.

Any legal action alleging a breach of this warranty (or any implied warranty) must be brought within one (1) year from the date the alleged breach first occurred. The exclusive jurisdiction and venue for any court action commenced by you under or relating to this limited warranty or any implied warranty(ies) shall be in the Circuit Court for Grady County, Georgia or United States District Court for the Middle District of Georgia.

We may be contacted as follows: Sailfish Boats, Attention: Customer Service Department, 2501 Industrial Park Drive, Cairo, GA 39828, USA. +1-229-377-2125.



[SAILFISHBOATS.COM](https://www.sailfishboats.com)

Specifications, features, equipment, options, colors, materials and trim are based on information available at time of printing and are subject to change without notice. Some accessories shown in photographs, or described, may not be standard equipment or even available as an option(s). Confirm availability of all accessories and equipment with an authorized Sailfish Boats dealer prior to purchase.

© 2022 Sailfish Boats.