



SAILFISH
BOATS



SAILFISH B O A T S





8
CENTER CONSOLES



22
DUAL CONSOLES

CONTENTS

CENTER CONSOLES

360CC	8
320CC	10
290CC	12
270CC	14
242CC	16
241CC	18
220CC	20

DUAL CONSOLES

325DC	22
275DC	24
245DC	26

WALK AROUNDS

320EXP	28
270WAC	29
240WAC	30
220WAC	31

BAY BOATS

2100BB	32
1900BB	33

FEATURES & OPTIONS

.....	36
-------	----



36
FEATURES & OPTIONS

SEATING	44
---------------	----

COVERS & SHADES	47
-----------------------	----

TOP OPTIONS	48
-------------------	----

HULL COLORS	49
-------------------	----



28

WALK AROUNDS



32

BAY BOATS



44

SEATING



47

COVERS & SHADES



48

TOP OPTIONS



49

HULL COLORS





FISHING FOCUSED

At its core, Sailfish is a fishing boat designed by anglers for anglers. It is built to withstand the rigors of inshore and offshore environments and is loaded with more standard fishing features than any other boat on the water. We offer a wide range of options that allow you to customize your Sailfish for whatever type of fishing you wish to pursue. From inshore to deep water, 19 to 36 feet, you will find a Sailfish that will accommodate any fishing adventure or family outing.



FAMILY FRIENDLY

Every Sailfish has the built-in versatility to be a serious fishing boat one day and a family fun boat the next. With comfortable full bow seating, stow away tables, abundant storage space, a roomy head and a retractable ski tow bar, your Sailfish transforms into the perfect platform for an exciting family day on the water. Sailfish also provides for family safety with the highest cockpit depth in the industry – designed to keep water outside and people safely inside. Each Sailfish also features the largest recessed, cockpit drains in their class, allowing the maximum amount of water to exit the deck, providing for an extra level of safety.





ADVANCED DESIGN

INNOVATIVE DESIGN

For more than 30 years, our designers have set the standard for innovation in the industry. Features you'll find on many boats on the market today were first spotted on a Sailfish. We continue to push the industry forward—ensuring our boats have the best possible layout, design and functionality for anglers and families alike. Sailfish has the most standard premium features in our class and pioneering design elements you won't find on other boats.

LIFETIME NO-ROT GUARANTEE

Sailfish uses absolutely no wood in our transom or hull - that means a lifetime free of rotting, guaranteed! Our boats are made from 100% composite materials with stainless steel hardware. You will find many beautiful "fiberglass" boats on the water today that actually incorporate plywood encapsulated in fiberglass, which leaves them vulnerable to rotting. Enjoy the peace of mind that comes from Sailfish's all composite construction.

INTELLIGENT ERGONOMICS

Have you ever been on a boat and thought, "Why on Earth did they do that?" Unless you're on a Sailfish, the answer is often because "they" added a feature as an afterthought. We design each boat with intelligent ergonomics from the start. When you reach for something, it's there—from cupholders, rod holders and hand-holds to switches, latches and toe rails. Our comfortable seating is ideal for lounging in the shallows or racing the sunrise offshore. All hinges and deck lids are recessed into the mounting surface, providing added safety for your feet. Plumbing and electrical systems are carefully engineered and installed for years of trouble-free operation and easy access.

10-YEAR HULL WARRANTY

Each Sailfish boat comes with a 10-year hull warranty. Our hulls and decks are reinforced with Kevlar® and Carbon Fiber for greater durability, and the entire stringer system is foam-filled for added safety. All Sailfish boats are built using the best materials and proven manufacturing techniques. From start to finish, there are no shortcuts taken anywhere in the production process. Our quality control team takes great pride in ensuring your Sailfish is examined for flaws and imperfections before it leaves the plant.

VARIABLE DEGREE STEPPED HULL

Our exclusive Variable Degree Stepped (VDS) Hull design provides the smoothest ride of any fishing boat on the market. Its unique design features three distinct running surfaces. The first has a deep deadrise that cuts through the water, and two others that provide lift and stability. In addition, Sailfish has the deepest gunwales in its class, designed to keep passengers safely inside and water out. The beautiful, wide bow flare also aids in keeping water from blowing back into the boat. Whether you're idling or cutting through the surf, our VDS hull is the optimal design for a comfortable, safe ride.



SAILTECH CONSTRUCTION

EXCLUSIVE VARIABLE DEGREE STEPPED (VDS) HULL

1. The 24° hull cuts through the water. This is the most aggressive angle used in the fishing boat segment.
2. The 23° hull provides lift and allows air under the hull, producing a softer ride with less friction for better performance and fuel economy. This lift allows you to reach the same speed without requiring as much horsepower as other boat brands.
3. The 22° hull provides stability needed for slow trolling or stopped positions.

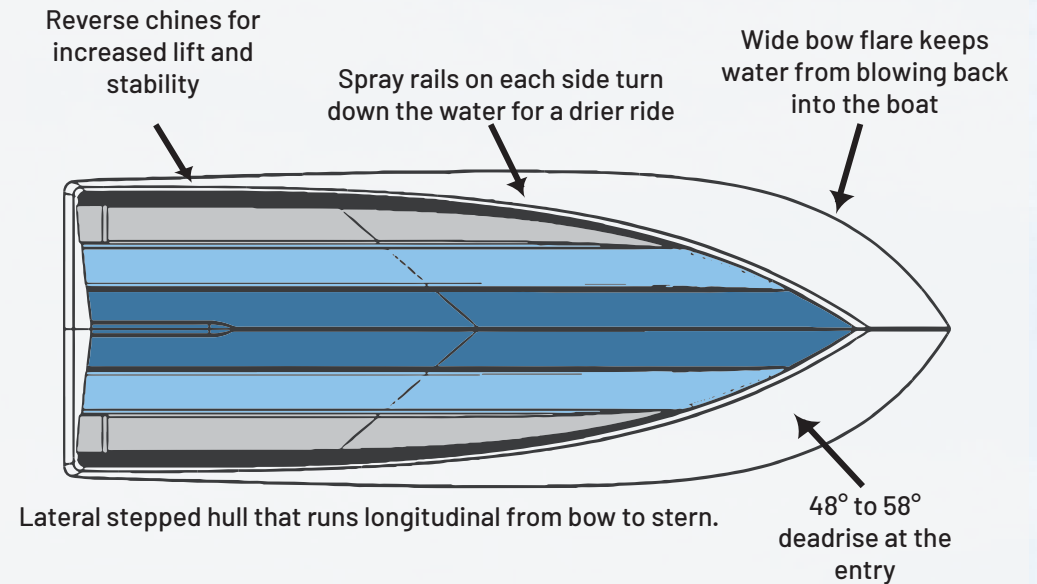
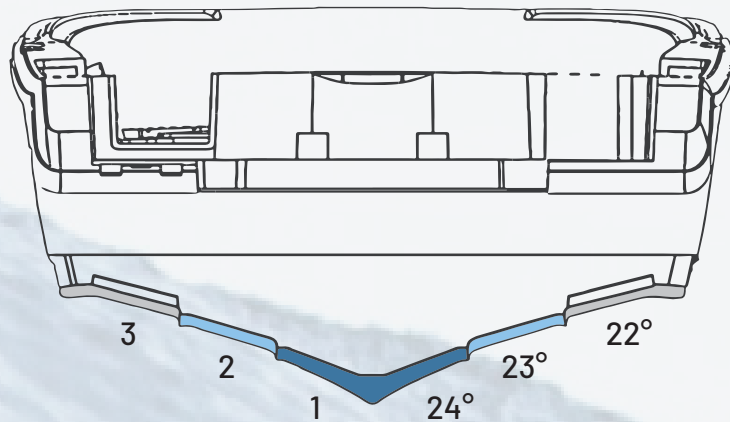

360CC

CENTER CONSOLE

36'
LOA HULL ONLY

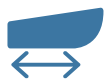

38'6"
LENGTH RIGGED



11'2"
BEAM



400 gal
FUEL CAPACITY



42 gal
FRESH WATER



12,700 lbs
WEIGHT



30"
COCKPIT DEPTH REAR



40"
BOW DEPTH



1050 hp
MAX HP



28"
DRAFT HULL



22°-24°
DEAD RISE (MULTI-ANGLE)



7
BATTERY CAPACITY



34
ROD HOLDERS (STANDARD)



YC
(YACHT CERTIFIED) PERSON CAPACITY



9'10"
BRIDGE CLEARANCE (HARD TOP)





 **YAMAHA**



www.SailfishBoats.com

320CC

CENTER CONSOLE

31'6"

LOA HULL ONLY

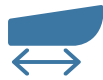

34'

LENGTH RIGGED



10'

BEAM



284gal

FUEL CAPACITY



21gal

FRESH WATER



10,500lbs

WEIGHT



31"

COCKPIT DEPTH REAR



40"

BOW DEPTH



700hp

MAX HP



22"

DRAFT HULL



22°-24°

DEAD RISE (MULTI-ANGLE)



3

BATTERY CAPACITY



30

ROD HOLDERS (STANDARD)



YC

(YACHT CERTIFIED) PERSON CAPACITY



8'10"

BRIDGE CLEARANCE (HARD TOP)





290CC

CENTER CONSOLE

28'6"

LOA HULL ONLY

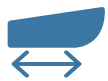

30'6"

LENGTH RIGGED



9'

BEAM



225gal

FUEL CAPACITY



14gal

FRESH WATER



8,000lbs

WEIGHT



30"

COCKPIT DEPTH REAR



40"

BOW DEPTH



600hp

MAX HP



21"

DRAFT HULL



22°-24°

DEAD RISE (MULTI-ANGLE)



3

BATTERY CAPACITY



16

ROD HOLDERS (STANDARD)



YC

(YACHT CERTIFIED) PERSON CAPACITY



8'10"

BRIDGE CLEARANCE (HARD TOP)



 **YAMAHA**



www.SailfishBoats.com

270CC

CENTER CONSOLE

26'2"

LOA HULL ONLY

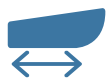

28'2"

LENGTH RIGGED



9'

BEAM



188gal

FUEL CAPACITY



14gal

FRESH WATER



6,700lbs

WEIGHT



30"

COCKPIT DEPTH REAR



40"

BOW DEPTH



400hp

MAX HP



18"

DRAFT HULL



22°-24°

DEAD RISE (MULTI-ANGLE)



3

BATTERY CAPACITY



12

ROD HOLDERS (STANDARD)



YC

(YACHT CERTIFIED) PERSON CAPACITY



8'6"

BRIDGE CLEARANCE (HARD TOP)





www.SailfishBoats.com

242CC

CENTER CONSOLE

24'
LOA HULL
ONLY

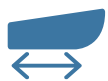

26'
LENGTH
RIGGED



9'
BEAM



146gal
FUEL
CAPACITY



14gal
FRESH
WATER



5,600 lbs
WEIGHT



30"
COCKPIT
DEPTH REAR



40"
BOW
DEPTH



300hp
MAX HP



18"
DRAFT
HULL



22°-24°
DEAD RISE
(MULTI-ANGLE)



3
BATTERY
CAPACITY



12
ROD
HOLDERS
(STANDARD)



10
PERSON
CAPACITY



8'6"
BRIDGE
CLEARANCE
(HARD TOP)



 **YAMAHA**



www.SailfishBoats.com

241CC

CENTER CONSOLE

24'

LOA HULL ONLY

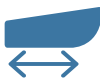

26'

LENGTH RIGGED



8'6"

BEAM



108gal

FUEL CAPACITY



14gal

FRESH WATER



5,000lbs

WEIGHT



27"

COCKPIT DEPTH REAR



32"

BOW DEPTH



300hp

MAX HP



18"

DRAFT HULL



22°-24°

DEAD RISE (MULTI-ANGLE)



2

BATTERY CAPACITY



12

ROD HOLDERS (STANDARD)



10

PERSON CAPACITY



8'6"

BRIDGE CLEARANCE (HARD TOP)



 **YAMAHA**



www.SailfishBoats.com

220CC

CENTER CONSOLE

21'3"
LOA HULL ONLY

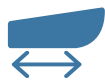

23'3"
LENGTH RIGGED



8'6"
BEAM



93 gal
FUEL CAPACITY



6 gal
FRESH WATER



4,450 lbs
WEIGHT



26"
COCKPIT DEPTH REAR



32"
BOW DEPTH



200 hp
MAX HP



18"
DRAFT HULL



22°-24°
DEAD RISE (MULTI-ANGLE)



2
BATTERY CAPACITY



10
ROD HOLDERS (STANDARD)



8
PERSON CAPACITY



8'4"
BRIDGE CLEARANCE (HARD TOP)





 **YAMAHA**



www.SailfishBoats.com



325DC

DUAL CONSOLE

31'6"
LOA HULL ONLY

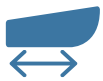

34'
LENGTH RIGGED



10'
BEAM



297 gal
FUEL CAPACITY



21 gal
FRESH WATER



11,066 lbs
WEIGHT



31"
COCKPIT DEPTH REAR



YC
(YACHT CERTIFIED)
PERSON CAPACITY



700hp
MAX HP



22"
DRAFT HULL



22°-24°
DEAD RISE
(MULTI-ANGLE)



3
BATTERY CAPACITY



15
ROD
HOLDERS
(STANDARD)



8'9"
BRIDGE
CLEARANCE
(HARD TOP)



 **YAMAHA**



www.SailfishBoats.com

275DC

DUAL CONSOLE

26'2"

LOA HULL ONLY

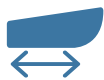

28'2"

LENGTH RIGGED



9'

BEAM



188 gal

FUEL CAPACITY



14 gal

FRESH WATER



7,040 lbs

WEIGHT



30"

COCKPIT DEPTH REAR



8'6"

BRIDGE CLEARANCE (HARD TOP)



400hp

MAX HP



18"

DRAFT HULL



22°-24°

DEAD RISE (MULTI-ANGLE)



3

BATTERY CAPACITY



8

ROD HOLDERS (STANDARD)



YC

(YACHT CERTIFIED) PERSON CAPACITY



 YAMAHA



www.SailfishBoats.com

245DC

DUAL CONSOLE

24'
LOA HULL
ONLY

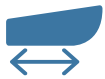

26'
LENGTH
RIGGED



8'6"
BEAM



120 gal
FUEL
CAPACITY



14 gal
FRESH
WATER



5,350 lbs
WEIGHT



27"
COCKPIT
DEPTH REAR



8'5"
BRIDGE
CLEARANCE
(HARD TOP)



300hp
MAX HP



18"
DRAFT
HULL



22°-24°
DEAD RISE
(MULTI-ANGLE)



2
BATTERY
CAPACITY



6
ROD
HOLDERS
(STANDARD)



12
PERSON
CAPACITY





www.SailfishBoats.com

320EXP EXPRESS



31'6"
LOA HULL ONLY



34'
LENGTH RIGGED



10'
BEAM



297 gal
FUEL CAPACITY



21 gal
FRESH WATER



11,850 lbs
WEIGHT



31"
COCKPIT DEPTH REAR



YC
(YACHT CERTIFIED)
PERSON CAPACITY



700hp
MAX HP



18"
DRAFT HULL



22°-24°
DEAD RISE
(MULTI-ANGLE)



3
BATTERY CAPACITY



20
ROD
HOLDERS
(STANDARD)



9'7"
BRIDGE
CLEARANCE
(HARD TOP)



270 WAC WALK AROUND



26'2"
LOA HULL
ONLY



28'2"
LENGTH
RIGGED



9'
BEAM



188gal
FUEL
CAPACITY



14gal
FRESH
WATER



7,400lbs
WEIGHT



30"
COCKPIT
DEPTH REAR



YC
(YACHT CERTIFIED)
PERSON CAPACITY



400hp
MAX HP



18"
DRAFT
HULL



22°-24°
DEAD RISE
(MULTI-ANGLE)



3
BATTERY
CAPACITY



14
ROD
HOLDERS
(STANDARD)



8'11"
BRIDGE
CLEARANCE
(HARD TOP)



240 WAC WALK AROUND

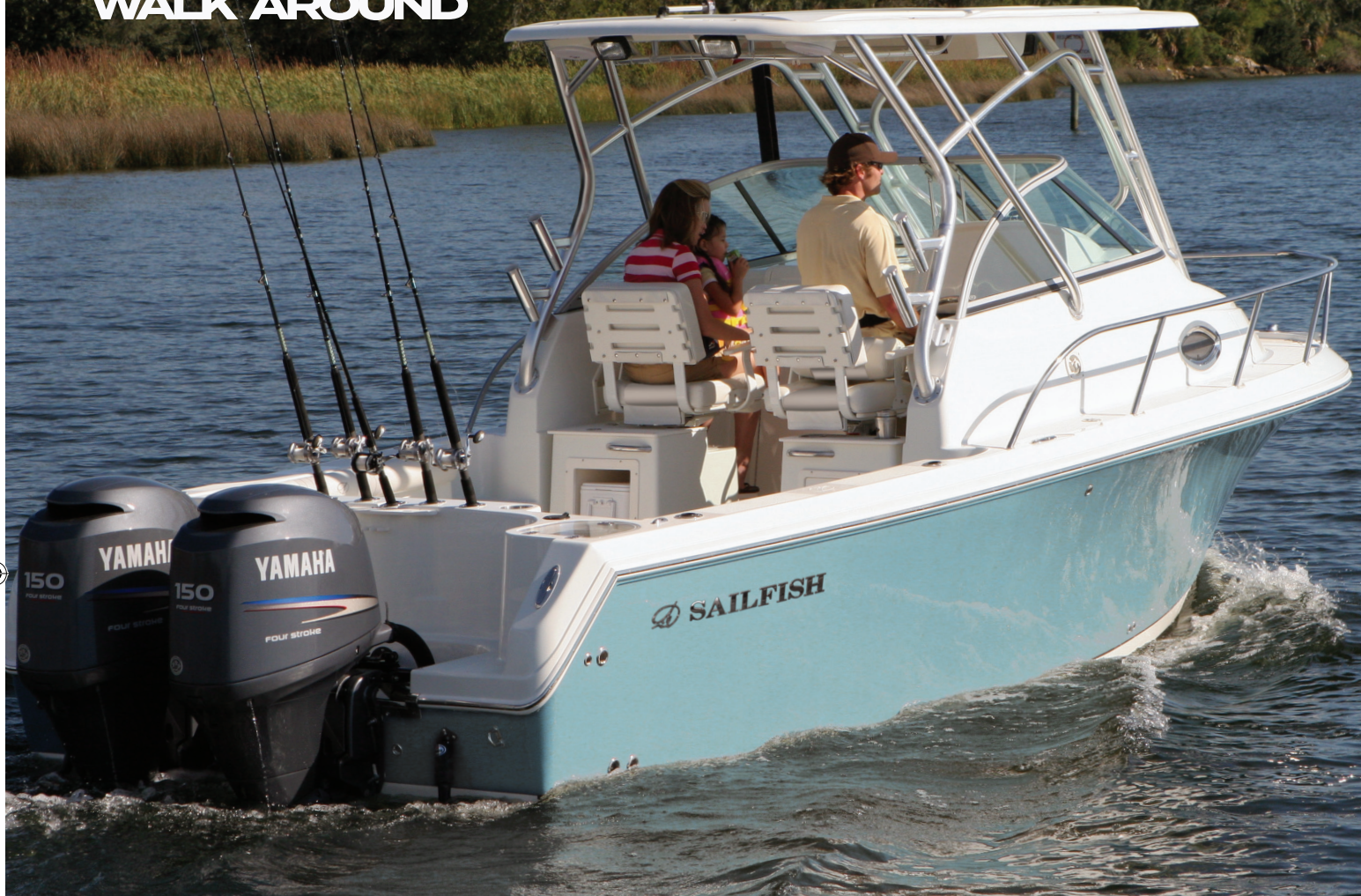

24' LOA HULL ONLY	26' LENGTH RIGGED	10' BEAM
146gal FUEL CAPACITY	14gal FRESH WATER	5,600lbs WEIGHT
30" COCKPIT DEPTH REAR	10 PERSON CAPACITY	300hp MAX HP
18" DRAFT HULL	22°-24° DEAD RISE (MULTI-ANGLE)	3 BATTERY CAPACITY
10 ROD HOLDERS (STANDARD)	8'9" BRIDGE CLEARANCE (HARD TOP)	



220 WAC WALK AROUND



21'3"
LOA HULL ONLY



23'6"
LENGTH RIGGED



8'6"
BEAM



93gal
FUEL CAPACITY



6gal
FRESH WATER



4,950lbs
WEIGHT



26"
COCKPIT DEPTH REAR



8
PERSON CAPACITY



200hp
MAX HP



18"
DRAFT HULL



22°-24°
DEAD RISE (MULTI-ANGLE)



2
BATTERY CAPACITY



8
ROD HOLDERS (STANDARD)



8'4"
BRIDGE CLEARANCE (HARD TOP)



2100 BAY



21'
LOA HULL ONLY



23'
LENGTH RIGGED



8'6"
BEAM



63gal
FUEL CAPACITY



5'5"
BRIDGE CLEARANCE (HARD TOP)



3,625lbs
WEIGHT



14
ROD HOLDERS (STANDARD)



7
PERSON CAPACITY



200hp
MAX HP



13"
DRAFT HULL



18°
DEADRISE



4
BATTERY CAPACITY



1900 BAY



19'
LOA HULL
ONLY



21'
LENGTH
RIGGED



8'6"
BEAM



53gal
FUEL
CAPACITY



5'5"
BRIDGE
CLEARANCE
(HARD TOP)



2,750lbs
WEIGHT



12
ROD
HOLDERS
(STANDARD)



5
PERSON
CAPACITY



200hp
MAX HP



13"
DRAFT
HULL



18°
DEADRISE



4
BATTERY
CAPACITY



www.SailfishBoats.com



SAILFISH LIFESTYLE

For over three decades, Sailfish has delivered on a promise of quality and innovation with its full lineup of reliable, versatile, stylish boats including Center Console, Dual Console, Walk Around and Bay models. Our Sailfish family grows with every boat that is sold, and we invite you to join in on the fun. Meet the sunrise for an offshore angling adventure, make afternoon watersport waves with the family and gather friends for a sunset dinner cruise- all aboard your new Sailfish boat. We combine fishability for the serious angler and premium comfort and safety features for the family. Today's Sailfish lets you get more from your boating investment.



FEATURES & OPTIONS

Each Fishing Focused, Family Friendly™ Sailfish Boat comes packed with an outstanding array of standard features. Available options allow you to create the boat of your dreams—perfectly suited to your preferences and needs.

From Bay Boats and Walk Arounds to Dual Consoles and Center Consoles, from 19 to 36 feet, there is a Sailfish Boat for your perfect day on the water.

We invite you to compare your desired features and options with other boat brands. You may find some that check most of the boxes—but you won't find another brand that offers the combination of Fishing Focused and Family Friendly™ features you'll find on a Sailfish, especially considering the value our top-quality boats offer.

And of course, there are the Sailfish exclusives that you only find on a Sailfish – such as our Variable Degree Stepped (VDS) Hull System, convenient Console Top Organizer and Intelligent Ergonomic Design that make Sailfish a stand out among the rest.

360CC

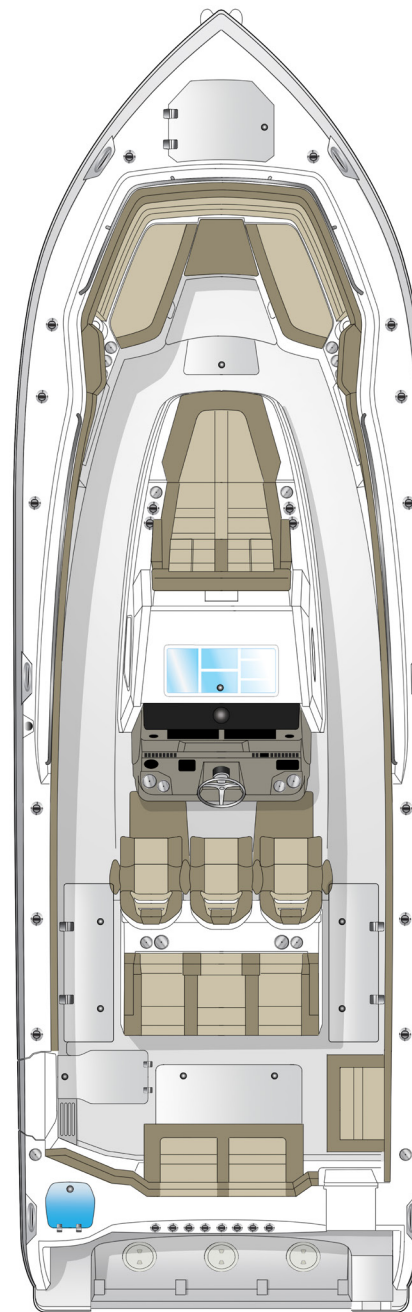

STANDARD FEATURES

- Boat**
- 3 Piece Construction w/ Cored Hull Sides
 - Boarding Ladder (4 step with grab handle)
 - Built In Rigging Tubes (From Bilge to Helm with pull tapes)
 - Carbon Fiber & Kevlar® Reinforced Deck & Hull
 - Closed Cell Foam Flotation
 - Cockpit Toe Rails
 - Dive Door w/ 4 Step Folding Ladder
 - Easy Access Electronics and Rigging Area
 - Edson Black Ops Steering Wheel w/ Deluxe Grip & Power Knob
 - Exclusive Dot Matrix Non-Skid Flooring
 - Exclusive VDS Hull Design (Variable Deadrise Stepped Hull)
 - Fender Cleats - Aft (2), Mid-Ship (2)
 - Flush Mount Hinges, Latches & Deck Plates
 - Hard Top w/ Vented Sun Roof, Articulating Rear Shade
 - Heavy Duty Stainless Steel Bow & Stern Eyes
 - Heavy Duty Stainless Steel Rub Rail
 - Heavy Duty High Performance Trim Tabs with Indicators & Auto Retract Feature
 - Integrated D Channel Hard Top Frame
 - In-Floor Fish Boxes (Insulated w/ Advanced Vacuum Pump, Non-Macerated)
 - Oversized Bilge Access
 - Power Assist Steering
 - Recessed SST Cup Holders (14)
 - Recessed 32 oz. SST Cup Holders (6)
 - Removable Table (Stern)
 - SailTech Composite Stringer System
 - SailTech Composite Transom
 - Thru Hull Windlass System
 - Walk Thru Transom Door with Wave Guard Step
- Bow**
- Fully Upholstered Convertible Bow Seating and Lounge Area w/ Power Adjustable Table/Bow Filler and Fold-Away Forward Facing Backrests
 - Twin insulated 80qt. Storage Boxes
- Electrical**
- 8 Spreader Lights w/ Four Way Control
 - Accessory Switch Panel w/Circuit Breakers
 - Built-In 4 Bank Battery Charger w/ LED Readout
 - Compass
 - Dock Side Power
 - Fusion/Wet Sounds Stereo System & USB Port
 - Fusion Transom & Bow Remote Control
 - LED Interior Cockpit & Bilge Lighting
 - LED Navigational Bow & Anchor Lights
 - Lumitec Underwater LED Lighting
 - Multiple 12 Volt DC Accessory Plugs
 - Push To Start Engines
 - Stainless Steel Refrigerator
 - VSR Battery Charging System
- Fishing**
- 42 & 32 Gallon Pressurized Circulating Baitwells
 - Built-In Tackle Storage
 - Sea Chest Baitwell Pump System
 - Tuna/Dive Door
- Head/Berth**
- Corian Counter Tops
 - Fresh Water SS Sink
 - Pilot's Berth
 - SST Port Light
 - Stand-up Shower w/ Curtain
 - Wood Framed Mirror, Wood Steps & Cabinetry
 - Yacht Style Flooring
- Helm**
- Adjustable Height Standing Driving Position
 - Comfort Zone Anti-Fatigue Pad
 - Deluxe Walk In Console Berth (Lockable) w/ SST Port Light
 - Glass Enclosure w/Vent, Wiper & Windshield Washer
 - Large Dash Area (Capable of flush mounting Twin 16" Screen or Triple 12" Screens)
 - Overhead Engine Monitor
- Plumbing**
- Automated Motor Flushing System
 - Automatic Bilge Pump (2 - 2000 GPH Aft - 750 GPH Forward)
 - Concealed Freshwater Electric Marine Head w/ Overboard Discharge

- Freshwater Stations (3) - (Transom, Leaning Post and Berth)
 - High Speed Livewell Pickup
 - On Deck Water Management System
 - Retractable Raw Water Wash Down
 - Self Bailing Cockpit (w/2 6" Oval Scupper Drains with Collector Box)
- Seating**
- 60" Hide-a-way Rear Seating
 - Bow Seating w/Forward Facing Backrest
 - Chase Lounge Seating w/ Fold Down Arm Rests
 - Leaning Post w/ 3 person Helm Seating and 3 Person Aft Facing Seat w/ Flip Down Armrest & Cup Holders, Cooler, Fridge, Storage, Powered Driver's Seat Slide and Landing for rear Facing Bottom Machine
- Storage**
- Console Top Tackle Organizer (CTO)
 - Dash Storage Pocket
 - Engel 80qt. Carry-On Cooler
 - Footrest Console Storage
 - Insulated Locking Coffin Box Storage
 - LP Glove Box w/ Charging Station
 - Recessed Rod Storage - Port & Starboard
 - Tackle Storage Port & Starboard
 - Twin 260 qt. Insulated Aft Fish Boxes
 - Twin Hard Top Storage Boxes
 - Under Gunwale Storage
- OPTIONS**
- Boat Options**
- Bow Shade
 - Bow Thruster
 - Console & Leaning Post Covers
 - Dash Misting System
 - Grand Slam 380 Outriggers w/ 15' Poles
 - Optimus 360 Joystick Steering
 - Powder Coating (Black)
 - Rod Holders, Extra Pair (2)
 - SeaKeeper Stabilization
 - Two Tone Hard Top
 - Yamaha Helm Master
- Electrical Options**
- A/C / Heat in Berth and Helm
 - Batteries for Twins (4) - 27 Series
 - Batteries for Triples (5) - 27 Series
 - Batteries for Inverter (3) - 31 Series
 - Garmin B175M Airmar Thru Hull Transducer w/ CHIRP
 - Garmin B175M Airmar Thru Hull Transducer w/ CHIRP
 - Garmin GMR Phantom™ 56 Radar
 - Garmin GMR Phantom™ Radar Cable & Power Cable
 - Garmin GMR™ 18 x HD Radome
 - Garmin GPSMap 7612xsv w/o Transducer
 - Garmin GPSMap 7616xsv w/o Transducer
 - Garmin Radar Cable & Power Cable
 - Garmin VHF Radio & Antenna
 - Offshore Inverter System
 - Rear Facing Camera for Hard Top
 - Rear Facing Garmin GPSMap 942xsv w/o Transducer
 - Remote Spot Light For Hard Top
 - Triple Garmin GPSMap 7612xsv w/o Transducer
 - Twin Garmin GPSMap 7612xsv w/o Transducer
 - Twin Garmin GPSMap 7616xsv w/o Transducer
- Seating Options**
- Aft Starboard 36" Folding Side Seat In Place of Storage Cabinet
 - Utility Leaning Post w/ Fridge, Electric Grill, Corian Counter Top, Livewell, Drivers Platform & Landing for Rear Facing Bottom Machine
- Engine Options**
- Yamaha**
- Triple F350
 - Twin F425
 - Triple F300
 - White Motor Upgrade
- Mercury**
- Triple 300 Verado
 - Triple 350 Verado
 - White Motor Upgrade



FEATURES & OPTIONS

320CC

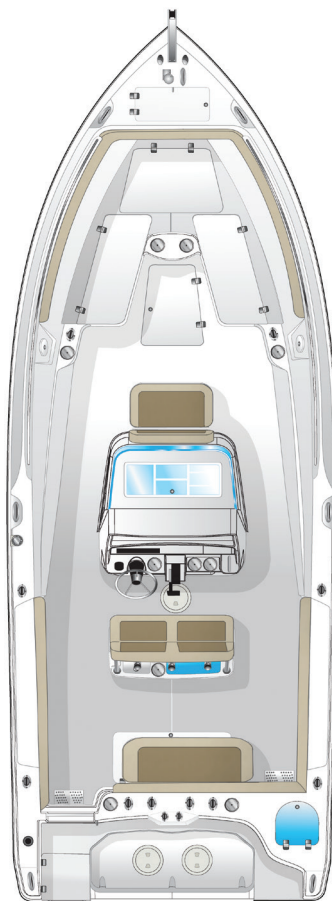

- Two door access in console for wiring access
 - Walk Thru Transom Door with Wave Guard Step
 - Yamaha 10 Micron Fuel Filter / Water Separator w/ SS Base
- Bow**
- Insulated Bow Fish Boxes with Overboard Drains (Twin 260 qt.)
- Electrical**
- 12 Volt DC Accessory Plug
 - Accessory Switch Panel w/Circuit Breakers
 - Compass
 - Electric Horn
 - Full Digital Instrumentation
 - LED Interior Cockpit & Bilge Lighting
 - LED Navigational Bow & Anchor Light
 - VSR Battery Charging System
- Fishing**
- Baitwell w/ LED Lighting (30 gal. Transom)
 - Baitwell w/ LED Lighting (35 gal. Leaning Post)
 - Built-In Tackle Storage (Aft Port & Starboard)
- Hardware**
- Fender Cleats Aft (2)
 - Flush Mount Hinges and Latches & Deck Plates
 - Heavy Duty Stainless Steel Bow & Stern Eyes
 - Heavy Duty Stainless Steel Rub Rail
 - Marine Grade Stainless Steel Hardware
 - Sailfish Engraved Transom Plate
 - Stainless Steel & Bronze Thru Hull Fittings
 - Stainless Steel Flush Mounted Pull-Up Cleats (6)
 - Stainless Steel Propeller(s)
 - Stainless Steel Rod Holders (12)
 - Stainless Steel Split Low Profile Bow Rails
- Head**
- Fresh Water Sink
 - Head Compartment Lighting
 - Lockable Head Door
 - Mirror
 - SeaDek® Flooring
 - SST Port Light
- Helm**
- Large Dash Area (Capable of flush mounting 16" Screen)
- Plumbing**
- Automatic Bilge Pump (2 - 2000 GPH Aft - 750 GPH Forward)
 - Freshwater Showers (3) - (Transom, Leaning Post and Head)
 - High Speed Livewell Pickup
 - Raw Water Wash Down
 - Self Bailing Cockpit (w/ (4) 2" Drains with Collector Box)
 - Sink with Faucet (In Head)
- Seating**
- 35 Gal. Livewell Leaning Post w/ Flip Up Bolsters, Backrest w/ Rod Holders, Footrest and 2 Drawer Storage

STANDARD FEATURES

- Boat**
- 6 Standard Hull Colors
 - Boarding Ladder (4 step with grab handle)
 - Built In Rigging Tubes (From Bilge to Helm with pull tapes)
 - Carbon Fiber & Kevlar® Reinforced Deck & Hull
 - Closed Cell Foam Flotation
 - Cockpit Bolsters
 - Cockpit Toe Rails
 - Exclusive Dot Matrix Non-Skid
 - Exclusive VDS Hull Design (Variable Deadrise Stepped Hull)
 - Faucet at Sink
 - Heavy Duty High Performance Trim Tabs with Indicators & Auto Retract Feature
 - Hydraulic Steering w/ Stainless Steel Tilt Wheel & Power Knob
 - In-Floor Fish Box (Insulated w/ Advanced Vacuum Pump, Non-Macerated)
 - Mercury Verado Fuel Filter / Water Separator
 - Oversized Bilge Access
 - Powder Coat for O.T.P. II or III (White)
 - Power Assist Steering
 - Recessed SST Cup Holders (13)
 - SailTech Composite Full Length Transom
 - SailTech Foam Filled Fiberglass Stringer System

- Captain's Chair LP Rod Rack (Avail. only with LP11, LP6 & LP7 without Ladderback Hard Top)
 - CL7 (C Series Motors Only)
 - Console & Leaning Post Covers
 - DLX Hard Top Acrylic Enclosure (3 Piece)
 - DLX Hard Top Enclosure (3 Piece)
 - Grand Slam Outriggers w/ 15' Poles
 - Optimus 360 Joystick Steering
 - Removable Bow Table
 - Thru Hull Windlass System
 - Two Tone Hard Top
 - Underwater LED Lights (3)
 - VesselView 703
 - Lewmar Bow Pre-Wire
 - Windlass w/ Polished Roller, SST Scuff Plate, SST Anchor, Rode & Chain
- Electrical Options**
- Built-In 3 Bank Battery Charger w/ LED Readout
 - Built-In Solar House Battery Charger (Hard Top Only)
 - Fusion/Wet Sounds Stereo System & USB Port
 - Fusion Transom Remote Control
 - Garmin B60 Airmar Thru Hull Transducer w/o CHIRP
 - Garmin B75M Airmar Thru Hull Transducer w/ CHIRP
 - Garmin GPSMap 1042xsv w/o Transducer
 - Garmin GPSMap 7612xsv w/o Transducer
 - Garmin GPSMap 7616xsv w/o Transducer
 - Garmin GMR™ 18 xHD Radome
 - Garmin GMR Fantom™ Radar Cable & Power Cable
 - Garmin GMR™ 18 xHD Radar
 - Garmin Radar Cable & Power Cable
 - Garmin VHF Radio & Antenna
 - Remote Spot Light For Hard Top
 - Wet Sounds LED Lighted Speakers Upgrade
- Plumbing Options**
- Electric Marine Head w/ Overboard Discharge
 - Misting System (For Hard Top only)
 - Motor Flushing System
 - Porta Potti (Pump Out)
- Seating Options**
- 58" Aft Folding Seat
 - Bow Filler Cushion
 - LP6 (Capt. Chairs LP w/35 GAL LW, Footrest & 2 Drawer Storage)
 - LP7 (Capt. Chairs LP w/Footrest & Built-in Twin Tackle Stations)
 - LP8 (Capt. Chairs Entertainment LP w/ Corian Counter Top & SS Drawers & Fridge)
 - LP11 Capt. Chairs LP w/Footrest & Built-in Tackle Station
 - Rear Cooler Seat - 125 Qt. Yeti

Optional Packages

- **Comfort Package**
Rear Jump Seats, Bow Cushion Bottoms, Bow Bolsters & Forward Facing Bow Backrests
 - **Entertainment Package**
Ski Tow Bar, Removable Bow Table, Fusion/Wet Sounds Stereo w/ USB Port & Underwater LED Lights (3)
 - **Offshore Tournament Pack I**
Deluxe Hard Top P.C. w/PDF Storage, Flip Up Bow Light, Transom Rod Holders, & Mid-Ship Fender Cleats
 - **Offshore Tournament Pack III**
Ladder Back Hard Top P.C. w/PDF Storage, Flip Up Bow Light, Transom Rod Holders & Mid-Ship Fender Cleats
 - **Powder Coat for O.T.P. I, II or III (Black)**
- Engine Options**
- Yamaha**
- Twin F300UCA
 - White Motor Upgrade (300HP Only)
- Mercury**
- Twin 250XXL Verado
 - Twin 300XXL Verado
 - Twin 350XXL Verado
 - White Motor Upgrade (200 & Up)

290CC

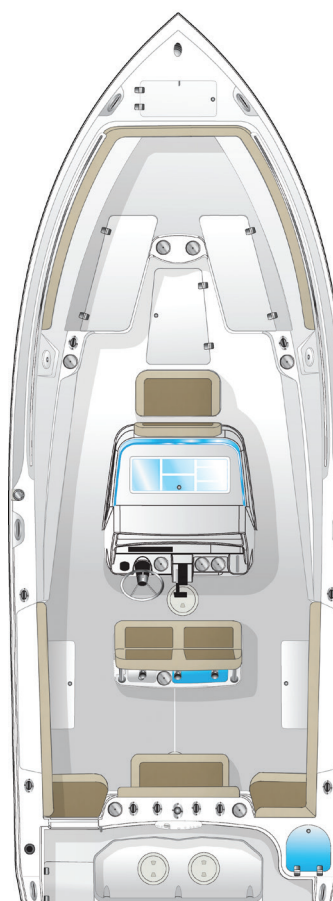

- Transom Mounted Tool & Washdown Hose Holder
 - Two door access in console for wiring access
 - Walk Thru Transom Door with Wave Guard Step
 - Yamaha 10 Micron Fuel Filter / Water Separator w/ SS Base
- Bow**
- Insulated Bow Fish Boxes with Overboard Drains (Twin 260 qt.)
- Electrical**
- 12 Volt DC Accessory Plug
 - Accessory Switch Panel w/Circuit Breakers
 - Compass
 - Electric Horn
 - Full Digital Instrumentation
 - LED Interior Cockpit & Bilge Lighting
 - LED Navigational Bow & Anchor Light
 - VSR Battery Charging System
- Fishing**
- Baitwell w/ LED Lighting (30 gal. Transom)
 - Baitwell w/ LED Lighting (35 gal. Leaning Post)
- Hardware**
- Fender Cleats Aft (2)
 - Flush Mount Hinges and Latches & Deck Plates
 - Heavy Duty Stainless Steel Bow & Stern Eyes
 - Heavy Duty Stainless Steel Rub Rail
 - Marine Grade Stainless Steel Hardware
 - Sailfish Engraved Transom Plate
 - Stainless Steel & Bronze Thru Hull Fittings
 - Stainless Steel Flush Mounted Pull-Up Cleats (6)
 - Stainless Steel Powder Coated Split Low Profile Bow Rails
 - Stainless Steel Propeller(s)
 - Stainless Steel Rod Holders (6)
- Head**
- Fresh Water Sink
 - Head Compartment Lighting
 - Lockable Head Door
 - Mirror
 - SeaDek® Flooring
 - SST Port Light
- Helm**
- Large Dash Area (Capable of flush mounting 16" Screen)
- Plumbing**
- Automatic Bilge Pump (2 - 2000 GPH Aft - 750 GPH Forward)
 - Freshwater Showers (3) - Transom, Leaning Post and Head
 - High Speed Livewell Pickup
 - Raw Water Wash Down
 - Self Bailing Cockpit (w/ (4) 2" Drains with Collector Box)
 - Sink with Faucet (In Head)

STANDARD FEATURES

- Boat**
- Boarding Ladder (4 step with grab handle)
 - Built In Rigging Tubes (From Bilge to Helm with pull tapes)
 - Carbon Fiber & Kevlar® Reinforced Deck & Hull
 - Closed Cell Foam Flotation
 - Cockpit Bolsters
 - Cockpit Toe Rails
 - Exclusive Dot Matrix Non-Skid
 - Exclusive VDS Hull Design (Variable Deadrise Stepped Hull)
 - Faucet at Sink
 - Heavy Duty High Performance Trim Tabs with Indicators & Auto Retract Feature
 - Hydraulic Steering w/ Tilt Stainless Steel Steering Wheel w/ Power Knob
 - In-Floor Fish Box (w/ Advanced Vacuum Pump, Non-Macerated (2))
 - Mercury Verado Fuel Filter / Water Separator
 - Oversized Bilge Access
 - Recessed SST Cup Holders (13)
 - SailTech Composite Full Length Transom
 - SailTech Foam Filled Fiberglass Stringer System

- Captain's Chair LP Rod Rack (Avail. only with LP11, LP6 & LP7 and OTP II)
 - CL7 (C Series Motors Only)
 - Console & Leaning Post Covers
 - DLX Hard Top Acrylic Enclosure (3 Piece)
 - DLX Hard Top Enclosure (3 Piece)
 - Grand Slam Outriggers w/ 15' Poles
 - Optimus 360 Joystick Steering
 - Power Assist Steering (Y) (Std on T300HP)
 - Remote Spot Light For Hard Top
 - Removable Bow Table
 - Thru Hull Windlass System
 - Two Tone Hard Top
 - Underwater LED Lights (3)
 - VesselView 703
 - Lewmar Bow Pre-Wire
 - Windlass w/ Polished Roller, SST Scuff Plate, SST Anchor, Rode & Chain
- Electrical Options**
- Built-In 3 Bank Battery Charger w/ LED Readout
 - Built-In Solar House Battery Charger (Hard Top Only)
 - Fusion/Wet Sounds Stereo System & USB Port
 - Fusion Transom Remote Control
 - Garmin B60 Airmar Thru Hull Transducer w/o CHIRP
 - Garmin B75M Airmar Thru Hull Transducer w/ CHIRP
 - Garmin GMR™ 18 xHD Radome
 - Garmin GPSMap 1042xsv w/o Transducer
 - Garmin GPSMap 7612xsv w/o Transducer
 - Garmin GPSMap 7616xsv w/o Transducer
 - Garmin Radar Cable & Power Cable
 - Garmin VHF Radio & Antenna
 - Wet Sounds LED Lighted Speakers Upgrade
- Hardware Options**
- Ski Tow Bar (Retractable)
- Plumbing Options**
- Electric Marine Head w/ Overboard Discharge
 - Misting System (For Hard Top only)
 - Motor Flushing System
 - Porta Potti with Cabinet
- Seating Options**
- 40" Aft Folding Seat
 - Bow Filler Cushion
 - LP6 (Capt. Chairs LP w/35 GAL LW, Footrest & 2 Drawer Storage)
 - LP7 (Capt. Chairs LP w/Footrest & Built-in Twin Tackle Stations)
 - LP8 (Capt. Chairs Entertainment LP w/ Corian Counter Top & SS Drawers & Fridge)
 - LP11 (Capt. Chairs LP w/Footrest & Built-in Tackle Station)
 - Rear Cooler Seat - 75 Qt. Yeti

Optional Packages

- **Comfort Package**
Rear Jump Seats, Bow Cushion Bottoms, Bow Bolsters & Forward Facing Bow Backrest
 - **Entertainment Package**
Ski Tow Bar, Removable Bow Table, Fusion/Wet Sounds Stereo w/ USB Port & Underwater LED Lights (3)
 - **Offshore Tournament Pack I**
Deluxe Hard Top P.C. w/PDF Storage, Flip Up Bow Light, Transom Rod Holders & Mid-Ship Fender Cleats
 - **Offshore Tournament Pack III**
Ladder Back Hard Top P.C. w/PDF Storage, Flip Up Bow Light, Transom Rod Holders & Mid-Ship Fender Cleats
 - **Powder Coat for OTP II or III (Back)**
- Engine Options**
- Yamaha**
- Twin F250XCA
 - Twin F300XCA
 - White Motor Upgrade (300HP Only)
- Mercury**
- Twin 250XL Verado
 - Twin 300XL Verado
 - White Motor Upgrade (200HP and Up)

For a complete listing of standard features and options visit www.sailfishboats.com

FEATURES & OPTIONS

270CC

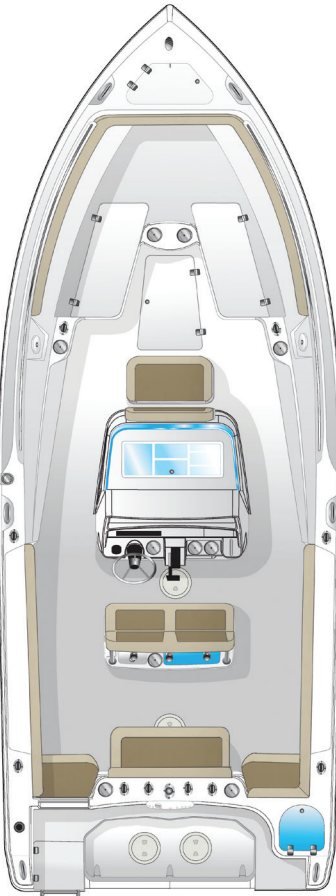

- Two door access in console for wiring access
- Walk Thru Transom Door with Wave Guard Step
- Yamaha 10 Micron Fuel Filter / Water Separator w/ SS Base
- Bow**
 - Insulated Bow Fish Boxes with Overboard Drains (Twin 260 qt.)
- Electrical**
 - 12 Volt DC Accessory Plug
 - Accessory Switch Panel w/Circuit Breakers
 - Compass
 - Electric Horn
 - Full Digital Instrumentation
 - LED Interior Cockpit & Bilge Lighting
 - LED Navigational Bow & Anchor Light
 - VSR Battery Charging System
- Fishing**
 - Baitwell w/ LED Lighting (30 gal. Transom)
 - Baitwell w/ LED Lighting (35 gal. Leaning Post)
- Hardware**
 - Fender Cleats Aft (2)
 - Flush Mount Hinges and Latches & Deck Plates
 - Heavy Duty Stainless Steel Bow & Stern Eyes
 - Heavy Duty Stainless Steel Rub Rail
 - Marine Grade Stainless Steel Hardware
 - Sailfish Engraved Transom Plate
 - Stainless Steel & Bronze Thru Hull Fittings
 - Stainless Steel Flush Mount Pull-Up Cleats (6)
 - Stainless Steel Propeller(s)
 - Stainless Steel Rod Holders (6)
 - Stainless Steel Split Low Profile Bow Rails
 - Wind Screen with Stainless Steel Grab Rail
- Head**
 - Fresh Water Sink
 - Head Compartment Lighting
 - Lockable Head Door
 - Mirror
 - Stainless Steel Port Light
 - SeaDek® Flooring
- Helm**
 - Large Dash Area (Capable of flush mounting 16" Screen)
- Plumbing**
 - Automatic Bilge Pump (2000 GPH Aft and 750 GPH Forward)
 - Freshwater Showers (2) - Transom And Head
 - High Speed Livewell Pickup
 - Raw Water Wash Down
 - Self Bailing Cockpit
 - Sink with Faucet (In Head)
- Seating**
 - LP5 (Leaning Post w/35 Gal. Livewell, Backrest, Footrest & 2 Drawer Storage)
 - Forward Helm Cooler Seat - Removable
- Storage**
 - Anchor Locker (Finished Fiberglass w/ Anchor Management System)
 - Battery Storage (In Head)
 - Console Top Tackle Organizer (CTO)
 - Deluxe Walk In Console (Lockable) w/ Stainless Steel Port Light
 - Downrigger Ball Holders (4)
 - Footrest Console Storage
 - In-Floor Storage Bow (w/ Bucket Holder)
 - Recessed Rod Storage - Port & Starboard
 - Vanity Storage
- OPTIONAL PACKAGES**
- Boat Options**
 - Bow Rod Holders (2)
 - Bow Shade (Hard Top Only)
 - Bow Thruster
 - Captain's Anti-Fatigue Pad
 - Captain's Chair LP Rod Rack (Avail. only with LP11, LP6 & LP7 and OTP I & OTP II)
- CL7 (C Series Motors Only)**
- Console & Leaning Post Covers
- DLX Hard Top Acrylic Enclosure (3 Piece)
- DLX Hard Top Enclosure (3 Piece)
- Grand Slam Outriggers w/ 15' Poles
- Optimus 360 Joystick Steering
- Power Assist Steering
- Removable Bow Table
- Thru Hull Windlass System
- Two Tone Hard Top
- Underwater LED Lights (3)
- VesselView 703
- Lewmar Bow Pre-Wire
- Windlass w/ Polished Roller, SST Scuff Plate, SST Anchor, Rode & Chain
- Electrical Options**
 - Built-In 3 Bank Battery Charger w/ LED Readout
 - Built-In Solar House Battery Charger (Hard Top Only)
 - Fusion/Wet Sounds Stereo System & USB Port
 - Fusion Transom Remote Control
 - Garmin B60 Airmar Thru Hull Transducer w/o CHIRP
 - Garmin B75M Airmar Thru Hull Transducer w/ CHIRP
 - Garmin GMR™ 18 x HD Radome
 - Garmin GPSMap 1042xsv w/o Transducer
 - Garmin GPSMap 7612xsv w/o Transducer
 - Garmin Radar Cable & Power Cable
 - Garmin VHF Radio & Antenna
 - Remote Spot Light For Hard Top
 - Wet Sounds LED Lighted Speakers Upgrade
- Hardware Options**
 - Ski Tow Bar (Retractable)
- Plumbing Options**
 - Electric Marine Head w/ Overboard Discharge
 - Misting System (For Hard Top only)
 - Motor Flushing System (Twin Motors Only)
 - Porta Potti (Pump Out)
 - Porta Potti w/ Slide Bracket Storage
- Seating Options**
 - 40" Aft Folding Seat
 - Bow Filler Cushion
 - LP6 (Capt. Chairs LP w/35 GAL LW, Footrest & 2 Drawer Storage)
 - LP8 (Capt. Chairs Entertainment LP w/ Corian Counter Top & SS Drawers & Fridge)
 - LP11 (Capt. Chairs LP w/Footrest & Built-in Tackle Station)
 - Rear Cooler Seat - 75 Qt. Yeti
- Optional Packages**
 - **Comfort Package**
Rear Jump Seats, Bow Cushion Bottoms, Bow Bolsters & Forward Facing Bow Backrest
 - **Entertainment Package**
Ski Tow Bar, Removable Bow Table, Fusion/Wet Sounds Stereo w/ USB Port & Underwater LED Lights (3)
 - **Offshore Tournament Pack I**
Hard Top w/PDF Storage, Flip Up Bow Light, Transom Rod Holders, Netting Package, Mid-Ship Fender Cleats
 - **Offshore Tournament Pack II**
Deluxe Hard Top P.C. w/PDF Storage, Flip Up Bow Light, Transom Rod Holders, Netting Package & Mid-Ship Fender Cleats
 - **Offshore Tournament Pack III**
Ladder Back Hard Top P.C. w/PDF Storage, Flip Up Bow Light, Transom Rod Holders, Netting Package & Mid-Ship Fender Cleats
 - **Powder Coat for O.T.P. I, II or III (Black)**
- Engine Options**
- Yamaha**
 - Twin F150XB
 - Twin F150XCA
 - Twin F200XB
 - Twin F200XCA
- Mercury**
 - Twin 150XL
 - Twin 200XL
 - Twin 200XL DTS
 - White Motor Upgrade (200 Only)

STANDARD FEATURES

- Boat**
 - Boarding Ladder (4 step with grab handle)
 - Built In Rigging Tubes (From Bilge to Helm with pull tapes)
 - Carbon Fiber & Kevlar® Reinforced Deck & Hull
 - Closed Cell Foam Flotation
 - Cockpit Bolsters
 - Cockpit Toe Rails
 - Exclusive Dot Matrix Non-Skid
 - Exclusive VDS Hull Design (Variable Deadrise Stepped Hull)
 - Heavy Duty High Performance Trim Tabs with Indicators & Auto Retract Feature
 - Hydraulic Steering w/ Stainless Steel Tilt Wheel & Power Knob
 - Mercury Verado Fuel / Water Separator
 - Oversized Bilge Access
 - Powder Coat for OTP I, II, or III (White)
 - Recessed Stainless Steel Cup Holders (11)
 - SailTech Composite Full Length Transom
 - SailTech Foam Filled Fiberglass Stringer System
 - Transom Mounted Tool & Washdown Hose Holder

242CC

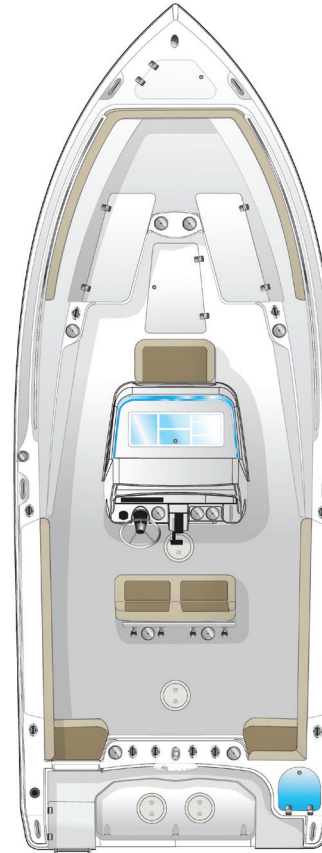

- Two door access in console for wiring access
- Walk Thru Transom Door with Wave Guard Step
- Yamaha 10 Micron Fuel Filter / Water Separator w/ SST Base
- Bow**
 - Insulated Bow Fish Boxes with Overboard Drains (Twin 260 qt.)
- Electrical**
 - 12 Volt DC Accessory Plug
 - Accessory Switch Panel w/Circuit Breakers
 - Compass
 - Electric Horn
 - Full Digital Instrumentation
 - LED Interior Cockpit & Bilge Lighting
 - LED Navigational Bow & Anchor Light
 - VSR Battery Charging System
- Hardware**
 - Fender Cleats Aft (2)
 - Flush Mount Hinges and Latches & Deck Plates
 - Heavy Duty SST Bow & Stern Eyes
 - Heavy Duty SST Rub Rail
 - Marine Grade SST Hardware
 - Sailfish Engraved Transom Plate
 - SST & Bronze Thru Hull Fittings
 - SST Flush Mount Pull-Up Cleats (6)
 - SST Propeller(s)
 - SST Rod Holders (6)
 - SST Split Low Profile Bow Rail
 - Wind Screen with SST Grab Rail
- Head**
 - Fresh Water Sink
 - Head Compartment Lighting
 - Lockable Head Door
 - Mirror
 - SeaDek® Flooring
- Helm**
 - Large Dash Area (Capable of flush mounting 16" Screen)
- Fishing**
 - Baitwell w/ LED Lighting (30 gal. Transom)
- Plumbing**
 - Automatic Bilge Pump (2000 GPH Aft and 750 GPH Forward)
 - Freshwater Showers (2) - (Transom and Head)
 - High Speed Livewell Pickup
 - Raw Water Washdown
 - Self Bailing Cockpit
 - Sink with Faucet (In Head)
- Seating**
 - LP2 (Leaning Post w/ Rod Holders & Removable Backrest)
 - Forward Helm Seating
- Storage**
 - Anchor Locker (Finished Fiberglass w/ Anchor Management System)
 - Battery Storage (In Head)
 - Deluxe Walk In Console (Lockable) w/ SST Port Light
 - Footrest Console Storage
 - In-Floor Storage (Bow w/ Bucket Holder)
 - Recessed Rod Storage - Port & Starboard
 - Vanity Storage
- OPTIONAL PACKAGES**
- Boat Options**
 - Bow Rod Holders (2)
 - Bow Shade, Hard Top Only
 - Captain's Anti-Fatigue Pad
 - CL7 (C Series Motors Only)
 - Console & Leaning Post Covers
 - Console Top Tackle Organizer (CTO)
 - Grand Slam Outriggers w/ 15' Poles
 - Hard Top Enclosure (3 Piece)
 - Hard Top w/ Radio Box & LED Lights
 - Power Assist Steering (M) - STD on 300
 - Power Assist Steering (Y)
 - Removable Bow Table
 - Two Tone Hard Top
 - Underwater LED Lights (3)
- VesselView 703**
- Lewmar Bow Pre-Wire
- Windlass w/ Polished Roller, SST Scuff Plate, SST Anchor, Rode & Chain
- Electrical Options**
 - Built-In 3 Bank Battery Charger w/ LED Readout
 - Built-In Solar House Battery Charger (Hard Top Only)
 - Fusion/Wet Sounds Stereo System & USB Port
 - Fusion Transom Remote Control
 - Garmin B60 Airmar Thru Hull Transducer w/o CHIRP
 - Garmin B75M Airmar Thru Hull Transducer w/ CHIRP
 - Garmin GPSMap 742xs w/o Transducer
 - Garmin GPSMap 1042xsv w/o Transducer
 - Garmin GPSMap 7612xsv w/o Transducer
 - Garmin GMR™ 18 x HD Radome
 - Garmin Radar Cable & Power Cable
 - Garmin VHF Radio & Antenna
 - Remote Spot Light for Hard Top
 - Wet Sounds LED Lighted Speakers Upgrade
- Hardware Options**
 - Ski Tow Bar (Retractable)
- Plumbing Options**
 - Electric Marine Head w/ Overboard Discharge
 - Misting System (For Hard Top only)
 - Motor Flushing System (Twins Only)
 - Porta Potti
 - Porta Potti (Pump Out)
- Seating Options**
 - Bow Filler Cushion
 - LP4 (White Fiberglass LP w/ cooler & Backrest)
 - LP13 (Double Mini Billfish Seats w/ flip up Bolsters & Arm Rest w/Tackle Storage)
- Optional Packages**
 - **Comfort Package**
Rear Jump Seats, Bow Cushion Rear Jump Seats, Bow Cushion Bottoms, Bow Bolsters & Forward Facing Bow Backrests
 - **Entertainment Package**
Ski Tow Bar, Removable Bow Table, Fusion/Wet Sounds Stereo w/ USB Port & Underwater LED Lights (3)
 - **Offshore Tournament Pack I**
Hard Top P.C. w/PDF Storage, Flip Up Bow Light, Transom Rod Holders, Netting Package & Mid-Ship Fender Cleats
 - **Powder Coat for O.T.P. I (Black)**
- Engine Options**
- Yamaha**
 - F300UCA
 - Twin F115XB
 - Twin F150XB
 - Twin F150XCA
 - White Painted Motor (n/a on twin 115 or 150's)
- Mercury**
 - Twin 150XL
 - 300XLL Verado
 - White Painted Motor (n/a on twin 150's)

STANDARD FEATURES

- Boat**
 - Boarding Ladder (4 step with grab handle)
 - Built In Rigging Tubes (From Bilge to Helm with pull tapes)
 - Carbon Fiber & Kevlar® Reinforced Deck & Hull
 - Closed Cell Foam Flotation
 - Cockpit Bolsters
 - Cockpit Toe Rails
 - Exclusive Dot Matrix Non-Skid
 - Exclusive VDS Hull Design (Variable Deadrise Stepped Hull)
 - Hydraulic Steering w/ Stainless Steel Tilt Wheel & Power Knob
 - Mercury Verado Fuel Filter / Water Separator
 - Oversized Bilge Access
 - Powder Coat for OTP I (White)
 - Recessed SST Cup Holders (11)
 - SailTech Composite Full Length Transom
 - SailTech Foam Filled Fiberglass Stringer System
 - SST Port Light (Head)
 - Transom Mounted Tool & Washdown Hose Holder
 - Trim Tabs w/ Indicator Switch & Built in Retractor



FEATURES & OPTIONS

241CC

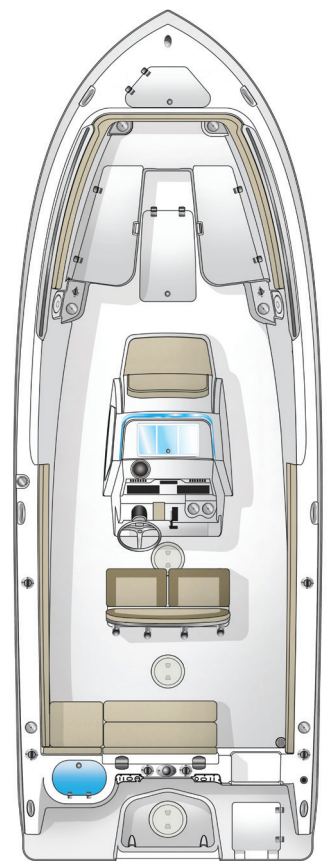

- Retractor**
 - Walk Thru Transom Door with Wave Guard Step
- Bow**
 - Built in Low Profile Bow Rails
 - Insulated Bow Fish Boxes with Overboard Drains (Twin 120 qt.)
- Electrical**
 - Accessory Switch Panel w/Circuit Breakers
 - Compass
 - Dual Battery Switch System
 - Electric Horn
 - Full Digital Instrumentation
 - LED Interior Cockpit & Bilge Lighting
 - LED Navigational Bow & Anchor Light
 - Multiple 12 Volt DC Accessory Plugs
- Hardware**
 - Engraved Transom Plate
 - Fender Cleats Aft (2)
 - Flush Mount Hinges, Latches & Deck Plates
 - Heavy Duty SST Bow & Stern Eyes
 - Heavy Duty SST Rub Rail
 - Marine Grade SST Hardware
 - SST & Bronze Thru Hull Fittings
 - SST Flush Mount Pull-Up Cleats (6)
 - SST Propeller
 - SST Rod Holders (6)
 - SST Split Low Profile Bow Rail
- Head**
 - Head Compartment Lighting
 - Lockable Head Door
 - Mirror
 - SeaDek® Flooring
- Helm**
 - Large Dash Area (Capable of flush mounting 12" Screen)
- Fishing**
 - Baitwell w/ LED Lighting (25 gal. Transom)
- Plumbing**
 - 14 Gal. Fresh Water Tank
 - Automatic Bilge Pump (2000 GPH Aft and 750 GPH Forward)
 - Freshwater Shower at the Transom
 - High Speed Live Well Pickup
 - Raw Water Wash down
 - Self Bailing Cockpit
- Seating**
 - AFT Flip-up Bolster Seating
 - Forward Helm Seat
 - LP2 (Leaning Post w/ Rod Holders & Removable Backrest)
- Storage**
 - Anchor Locker w/ Anchor Management System
 - Battery Storage (In Head Compartment)
 - Built-In Insulated 27qt. Cooler/Storage
 - Deluxe Walk In Console (Lockable) w/ SST Port Light
 - Footrest Console Storage
 - In-Floor Storage Bow
 - Recessed Rod Storage - Port & Starboard
 - Storage Box & Phone Station in The Dash

STANDARD FEATURES

- Boat**
 - 10 Micron Yamaha Fuel Filter / Water Separator w/ SST Base
 - Boarding Ladder (4 step w/ grab handle)
 - Built In Rigging Tubes (From Bilge to Helm)
 - Carbon Fiber & Kevlar® Reinforced Deck & Hull
 - Cockpit Bolsters
 - Exclusive Dot Matrix Non-Skid
 - Exclusive VDS Hull Design (Variable Deadrise Stepped Hull)
 - Hydraulic Steering w/ Tilt Wheel & SST Steering Wheel w/ Power Knob
 - Large door access in console for wiring access
 - Oversized Bilge Access
 - Powder Coat for OTP I (White)
 - Pull Out Transom Shower
 - Recessed SST Cup Holders (7)
 - SailTech Composite Full Length Transom
 - SailTech Foam Filled Fiberglass Stringer System
 - SST Port Light (Head)
 - Transom Mounted Tool & Raw Water Wash down Hose Holder
 - Trim Tabs w/ Indicator Switch & Built in

- Plate, Anchor, Rode & Chain**
- Electrical Options**
 - Built-In 2 Bank Battery Charger
 - Built-In Solar House Battery Charger (Hard Top Only)
 - Fusion/Wet Sounds Stereo System & USB Port
 - Fusion Transom Remote Control
 - Garmin B60 Airmar Thru Hull Transducer w/o CHIRP
 - Garmin B75M Airmar Thru Hull Transducer w/ CHIRP
 - Garmin GMR™ 18 xHD Radome
 - Garmin GPSMap 742xs w/o Transducer
 - Garmin GPSMap 7612xsv w/o Transducer
 - Garmin GPSMap 1042xsv w/o Transducer
 - Garmin Radar Cable & Power Cable
 - Standard Horizon VHF Radio & Antenna
 - Wet Sounds LED Lighted Speakers Upgrade
- Hardware Options**
 - Ski Tow Bar (Retractable)
- Plumbing Options**
 - Freshwater Electric Head w/Holding Tank, (with deck pump out fitting)
 - Misting System (For Hard Top only)
 - Porta Potti
 - Porta Potti (Pump Out)
- Seating Options**
 - Bow Filler Cushion
 - LP12 (Twin Passenger Billfish Seat w/ flip up Bolsters & Arm Rest w/Tackle Storage)
 - Rear Jump Seat (Port side)
- Optional Packages**
 - **Comfort Package** (Bow Cushion Bottoms, Bow Bolsters & Forward Facing Bow Backrest)
 - **Entertainment Package** (Ski Tow Bar, Removable Bow Table, Fusion/Wet Sounds Stereo w/USB Port & LED Underwater Lighting)
 - **Offshore Tournament Pack I** (241 Deluxe Hard Top, P.C. w/PFD Storage, Flip Up Bow Light, Transom Rod Holders, Netting Package & Mid-Ship Fender Cleats)
 - **Powder Coat for OTP I (Black)**
- Engine Options**
- Yamaha**
 - Single Yamaha F200XB
 - Single Yamaha F250XB
 - Single Yamaha F250XCA
 - Single Yamaha F300XCA
 - Single Yamaha White Motor Upgrade (Only Available on 300HP)
- Mercury**
 - Single Mercury 200XL
 - Single Mercury 200XL DTS
 - Single Mercury 250XL Verado
 - Single Mercury 300XL Verado
 - Single Mercury White Motor Upgrade

OPTIONS

- Boat Options**
 - Bow Rod Holders
 - Bow Shade (For Hard Tops Only)
 - Captain's Anti-Fatigue Pad
 - CL7 (C Series Motors Only)
 - Console & Leaning Post Covers
 - Console Top Tackle Organizer (CTO)
 - Grand Slam Outriggers w/ 15' Poles
 - Hard Top Enclosure (3 Piece)
 - Power Assist Steering (M) Std. on Verado
 - Power Assist Steering (Y)
 - Removable Bow Table
 - Two Tone Hard Top
 - Underwater LED Lights (2)
 - VesselView 502
 - Lewmar Bow Pre-Wire
 - Windlass w/ Polished Roller, SST Scuff

220CC

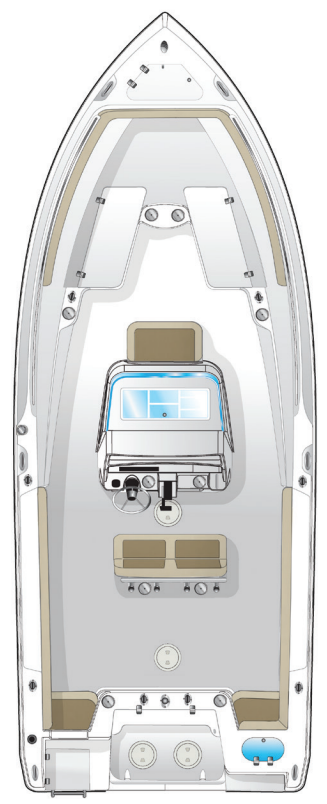

- Breakers**
 - Compass
 - Dual Battery Switch
 - Electric Horn
 - Full Digital Instrumentation
 - LED Interior Cockpit & Bilge Lighting
 - LED Navigational Bow & Anchor Light
- Fishing**
 - Baitwell w/ LED Lighting (25 gal. Transom)
 - Built-In Tackle Storage (Aft Under Transom Door)
- Hardware**
 - Fender Cleats Aft (2)
 - Flush Mount Hinges, Latches & Deck Plates
 - Heavy Duty Stainless Steel Bow & Stern Eyes
 - Heavy Duty Stainless Steel Rub Rail
 - Marine Grade Stainless Steel Hardware
 - Sailfish Engraved Transom Plate
 - Stainless Steel & Bronze Thru Hull Fittings
 - Stainless Steel Flush Mount Pull-Up Cleats (6)
 - Stainless Steel Propeller
 - Stainless Steel Rod Holders (6)
 - Stainless Steel Split Low Profile Bow Rails
 - Wind Screen with Stainless Steel Grab Rail
- Head**
 - Head Compartment Lighting
 - Lockable Head Door
 - Mirror
- Helm**
 - Large Dash Area (Capable of flush mounting 8" Screen)
- Plumbing**
 - Automatic Bilge Pump (2000 GPH)
 - Freshwater Shower (Transom)
 - High Speed Livewell Pickup
 - Raw Water Washdown
 - Self Bailing Cockpit
- Seating**
 - LP2 (Leaning Post w/ Rod Holders & Removable Backrest)
 - Forward Helm Seating
- Storage**
 - Battery Storage (Bilge Compartment)
 - Deluxe Walk In Console (Lockable) w/ Stainless Steel Port Light
 - Footrest Console Storage
 - Recessed Rod Storage - Port & Starboard

STANDARD FEATURES

- Boat**
 - Anchor Locker
 - Boarding Ladder (3 step)
 - Built In Rigging Tubes (From Bilge to Helm with pull tapes)
 - Carbon Fiber & Kevlar® Reinforced Deck & Hull
 - Closed Cell Foam Flotation
 - Cockpit Bolsters
 - Exclusive Dot Matrix Non-Skid
 - Exclusive VDS Hull Design (Variable Deadrise Stepped Hull)
 - Hydraulic Steering w/ Stainless Steel Tilt Wheel & Power Knob
 - Mercury Verado Fuel Filter / Water Separator
 - Powder Coat for OTP I (White)
 - Recessed SST Cup Holders (8)
 - SailTech Composite Full Length Transom
 - SailTech Foam Filled Fiberglass Stringer System
 - Trim Tabs w/ Indicator Switch & Built-In Retractor
 - Walk Thru Transom Door with Wave Guard Step
 - Yamaha 10 Micron Fuel Filter / Water Separator w/ SS Base
- Bow**
 - Insulated Bow Fish Boxes with Overboard Drains (Twin 224 qt.)
- Electrical**
 - 12 Volt DC Accessory Plug
 - Accessory Switch Panel w/Circuit

- Optional Packages**
 - **Comfort Package** (Rear Jump Seats, Bow Cushion Bottoms, Bow Bolsters & Forward Facing Bow Backrest)
 - **Entertainment Package** (Ski Tow Bar, Removable Bow Table & Stereo w/ USB Port & Underwater LED Lights (2))
 - **Offshore Tournament Pack I** (220 Deluxe Hard Top, Flip Up Bow Light, Transom Rod Holders, Netting Package & Mid-Ship Fender Cleats)
 - **Powder Coat for OTP I (Black)**
- Engine Options**
- Yamaha**
 - F150XB
 - F150XCA
 - F200XB
 - F200XCA
- Mercury**
 - 150XL
 - 200XL
 - 200XL DTS
 - White Mercury Upgrade (200XL Only)

For a complete listing of standard features and options visit www.sailfishboats.com

FEATURES & OPTIONS

325DC



STANDARD FEATURES

- Boat**
- Boarding Ladder (4 step with grab handle)
 - Built In Rigging Tubes (From Bilge to Helm with pull tapes)
 - Carbon Fiber & Kevlar® Reinforced Deck & Hull
 - Closed Cell Foam Flotation
 - Cockpit Bolster Pads
 - Corian Counter Tops
 - Exclusive Dot Matrix Non-Skid
 - Exclusive VDS Hull Design (Variable Deadrise Stepped Hull)
 - Mercury Verado Fuel Filter / Water Separator
 - Passenger Pod w/ Top Mounted Built-In Storage Box
 - Powder Coated hard Top w/4 Rod Holders, Docking Lights, Spreader Lights, Overhead Lighting, PFD Storage & 2 Speakers
 - Powder Coated Walk Thru Windshield w/ Tempered Glass
 - Power Assist Hydraulic Steering w/ Tilt Stainless Steering Wheel (Evo Pro w/ Leather Grips & Power Knob)
 - Recessed SST Cup Holders (20)
 - SailTech Composite Full Length Transom
 - SailTech Foam Filled Fiberglass Stringer System

- SST Port Light (Head Compartment)
- Starboard Cockpit entry Step / Mid-Ship
- Towel Rack and Net Storage In the Starboard Storage Compartment Door
- Trim Tabs / High Performance Dual Ram / Heavy Duty With Indicator Switch & Built In Auto Retract Feature
- Walk Thru Transom Door with Wave Guard & Step
- Windshield Wiper (Captain's Side w/Freshwater)
- Yamaha 10 Micron Fuel Filter / Water Separator w/ SST Base

- Bow**
- Bow Block Off Door
 - Bow Bottom and Backrest Cushions
 - Powder Coated Built in Low Profile Bow Rails

- Cockpit Galley**
- 12 Volt DC Accessory Plug (4)
 - Corian Counter Top w/ Sink with Faucet, Fridge, Trash Can w/ Filler and Cutting Board
 - LED Strip Lighting
 - SST Soap Dispenser

- Electrical**
- 12 Volt DC Accessory Plug
 - Accessory Switch Panel w/Circuit Breakers
 - Compass
 - Electric Horn
 - Electrically Actuated Bilge Access
 - Full Digital Instrumentation w/ Yamaha CommandLink or Mercury Vessel View
 - Fusion/Wet Sounds Stereo System w/ AMP, Sub-Woofers, Transom Remote Control & USB Port
 - LED Interior Cockpit & Bilge Lighting
 - LED Navigational Pop Up Bow & Anchor Light
 - VSR Battery Charging System

- Fishing**
- 8 SST Deck Mounted Rod Holders
 - Aft In-Floor Fish Box
 - Baitwell w/ LED Lighting
 - Insulated Bow Fish Boxes with Overboard Drains

- Hardware**
- 8" Stainless Steel Flush Mount Pull-Up Cleats (6)
 - Anchor Locker w/ Polished SST Thru The Hull Windlass
 - Fender Cleats Aft (2)
 - Finished Fiberglass Head
 - Flush Mount Hinges and Latches & Deck Plates
 - Galley / Head Compartment Lighting
 - Heavy Duty Stainless Steel Bow & Stern Eyes
 - Heavy Duty Stainless Steel Rub Rail
 - Lockable Galley / Head Door
 - Mirror Galley / Head Compartment
 - Sailfish Engraved Transom Plate
 - Stainless Steel & Bronze Thru Hull Fittings
 - Stainless Steel Marine Grade Hardware
 - Stainless Steel Propellers
 - Stainless Steel Retractable Ski Tow Bar

- Head**
- SeaDek® Flooring
 - SST Soap Dispenser In The Galley / Head Compartment

- Helm**
- Large Dash Area For Flush Mounting 12" Electronics

- Plumbing**
- 21 gal. Freshwater Tank
 - 4 - 2" Drains w/Collector Boxes for Self Bailing Cockpit
 - Automatic Bilge Pumps (Aft 2 - 2000 GPH & Forward 1 - 750 GPH)
 - Freshwater Stations (3) (Galley / Head Cockpit Galley & Transom)
 - High Speed Livewell Pickup
 - Pull Out Shower in Galley / Head
 - Pull Out Transom Shower
 - Raw Water Wash Down
 - Sink with Faucet In The Galley / Head & Cockpit Galley

- Seating**
- Aft Fold Down Seat 48"
 - Deluxe Double Wide Captain's Chair with Flip Up Bolster & Arm Rest

- Fold Out Port Mid-Ship Passenger Seat 27"
- Passenger Seat w/ Storage, Cup Holders & Cooler
- Port Aft Fold Down Seat 52"

- Storage**
- Battery Storage (Bilge Compartment)
 - Built-In Bow Cooler, Drains Overboard 25 QT.
 - Galley / Head with Net Storage and Cabinet
 - In Floor Ski Locker (Mid-Ship)
 - In Floor Storage Box in the Bow
 - Recessed Rod Storage Starboard Side Aft
 - SST Facing Storage Center w/ Pull Out Drawers
 - Starboard Closet with Organizer Shelving
 - Starboard Helm Storage with Nets

OPTIONS

- Boat Options**
- Bow Shade (Bow Rod Holders Included)
 - Bow Thruster
 - Cockpit & Bow Covers
 - Grand Slam Outriggers w/ 15' Poles
 - Hard Top Enclosure (3 Piece)
 - In-Floor Rod Storage
 - Optimus 360 Joystick Steering
 - Removable Table Bow
 - Removable Table Stern
 - Sureshade ATF™
 - Sureshade MTF™
 - Two Tone Hard Top
 - Underwater Led Lights (3)

- Electronics & Sound System Options**
- Built-In 3 Bank Battery Charger w/ LED Readout
 - Garmin GPSMap 1042xsv w/o Transducer
 - Garmin GPSMap 7612xsv w/o Transducer
 - Garmin Radar & Power Cable
 - Garmin Thru Hull Transducer Airmar B60 (50/200Khz)
 - Garmin Thru Hull Transducer Airmar B75M (80/133Khz)
 - Garmin GMR Fantom™ Radar Cable & Power Cable
 - Garmin GMR Fantom™ 56 Radar
 - Garmin VHF Radio & Antenna
 - Remote Spot Light on Hard Top
 - Wet Sounds LED Lighted Speakers Upgrade

- Hardware Options**
- Mid-Ship Fender Cleats (2)

- Plumbing Options**
- Bow Shower
 - Misting System For Hard Top
 - Motor Flushing System

- Seating Options**
- Aft Fold Down Seat (48")
 - Deluxe Double Wide Captain's Chairs with Flip Up Bolster & Arm Rest
 - Fold Out Port Mid-Ship Passenger Seat (27")
 - Passenger Seat w/ Storage, Cup Holders & Cooler
 - Port Aft Fold Down Seat

- Optional Packages**
- Galley Package**
Shore Power, Electric Grill w/ Inverter/Battery Charger, Microwave & Built-In 3 Bank Battery Charger w/ LED Readout
 - Galley Pack Grill w/ Inverter/Battery Charger Delete**

- Engine Options**
- Yamaha
- Twin F300UCA
 - White Motor Upgrade (300HP Only)

- Mercury
- Twin 250XXL Verado
 - Twin 300XXL Verado
 - Twin 350XXL Verado
 - White Motor Upgrade

275DC



STANDARD FEATURES

- Boat**
- Boarding Ladder (4 step with grab handle)
 - Built In Rigging Tubes (From Bilge to Helm with pull tapes)
 - Carbon Fiber & Kevlar® Reinforced Deck & Hull
 - Closed Cell Foam Flotation
 - Cockpit Bolster Pads
 - Corian Counter Tops (Head)
 - Exclusive Dot Matrix Non-Skid
 - Exclusive VDS Hull Design (Variable Deadrise Stepped Hull)
 - Hydraulic Steering w/ Stainless Steel Tilt Steering Wheel (Evo Pro w/ Leather Grips & Power Knob)
 - In-Floor Fish Box (w/ Advanced Vacuum Pump, Non Macerated)
 - Mercury Verado Fuel Filter / Water Separator
 - Oversized Bilge Access
 - Powder Coated Walk Thru Windshield w/ Tempered Glass
 - Recessed SST Cup Holders (17)
 - SailTech Composite Full Length Transom
 - SailTech Foam Filled Fiberglass Stringer System
 - Transom Mounted Tool & Washdown Hose Holder
 - Walk Thru Transom Door with Wave Guard Step
 - Yamaha 10 Micron Fuel Filter / Water Separator w/ SS Base

- Bow**
- Bow Block Off Door
 - Bow Bottom and Backrest Cushions
 - Chaise Lounge Style Seating

- Cockpit Galley**
- 12 Volt DC Accessory Plug
 - Corian Counter Tops and Sink Filler with Cutting Board
 - LED Strip Lighting
 - Pullout Drawers (2)
 - Tackle/Storage Center

- Hardware**
- Fender Cleats Aft (2)
 - Flush Mount Hinges and Latches & Deck Plates
 - Heavy Duty Stainless Steel Bow & Stern Eyes
 - Heavy Duty Stainless Steel Rub Rail
 - Sailfish Engraved Transom Plate
 - Stainless Steel & Bronze Thru Hull Fittings
 - Stainless Steel Flush Mount Pull-Up Cleats (6)
 - Stainless Steel Marine Grade Hardware
 - Stainless Steel Powder Coated Split Low Profile Bow Rails
 - Stainless Steel Propeller(s)
 - Stainless Steel Rod Holders (4)

- Head**
- Finished Fiberglass Head
 - Head Compartment Lighting
 - Lockable Head Door
 - Mirror
 - SeaDek® Flooring
 - Sink w/ Faucet
 - SST Port Light
 - Towel Rack, TP Holder and Storage

- Helm**
- Large Dash Area (Capable of flush mounting 12" Screen)

- Electrical**
- 12 Volt DC Accessory Plug
 - Accessory Switch Panel w/Circuit Breakers
 - Compass
 - Electric Horn
 - Full Digital Instrumentation
 - LED Interior Cockpit & Bilge Lighting
 - LED Navigational Bow & Anchor Light
 - VSR Battery Charging System

- Fishing**
- Baitwell w/ LED Lighting (30 gal. Transom)
 - Insulated Bow Fish Boxes with Overboard Drains (Twin 240 qt.)

- Plumbing**
- 14 gal. Freshwater Tank
 - Automatic Bilge Pump (2000 GPH Aft and 750 GPH Forward)
 - Freshwater Showers (2) - Transom And Head
 - High Speed Livewell Pickup
 - Pull Out Shower in Head
 - Pull Out Transom Shower
 - Raw Water Wash Down
 - Self Bailing Cockpit
 - Sink with Faucet (Galley)

- Seating**
- Aft Folding Seat 58" Flip up
 - Deluxe Captains Chair with Flip Up Bolster
 - Flip Flop Lounge Seat w/ Storage & Insulated Cooler

- Storage**
- Anchor Locker (Finished Fiberglass w/ Anchor Management System)
 - Battery Storage (Bilge Compartment)
 - Fiberglass Console Storage
 - In Floor Ski Locker (Mid-Ship)
 - In Floor Storage (Bow)
 - Recessed Rod Storage - Port & Starboard
 - Storage Center w/ Pull Out Drawers (Cockpit Galley)

OPTIONS

- Boat Options**
- 12 Volt Refrigerator
 - 2 Additional Rod Holders (In Splashwell)
 - Additional Table Base
 - Bow Shade (Bow Rod Holders Included)
 - Bow Thruster
 - Cockpit & Bow Covers
 - CL7 (C Series Motors Only)
 - Electric Grill
 - Fiberglass Hard Top
 - Flip Up Bow Light (NA w/ Top Mounted

- Windlass**
- Grand Slam Outriggers w/ 15' Poles
 - Hard Top Enclosure (3 Piece)
 - In-Floor Rod Storage (3)
 - Optimus 360 Joystick Steering
 - Power Assist Steering (Standard w/ Verados)
 - Propane Grill
 - Remote Spot Light for Hard Top
 - Removable Bow Table
 - Ski Tow Bar (Retractable)
 - SureShade MTF™
 - Thru Hull Windlass System
 - Transom Rod Holders
 - Two Tone Hard Top
 - Underwater LED Lights (3)
 - VesselView 703
 - Lewmar Bow Pre-Wire
 - Windlass w/ Polished Roller, SST Scuff Plate, Anchor, Rode & Chain
 - Windshield Wiper (Captain's Side)

- Electrical Options**
- Built-In 3 Bank Battery Charger w/ LED Readout
 - Built-In Solar House Battery Charger (Hard Top Only)
 - Fusion/Wet Sounds Stereo System & USB Port
 - Fusion Transom Remote Control
 - Garmin B60 Airmar Thru Hull Transducer w/o CHIRP
 - Garmin B75M Airmar Thru Hull Transducer w/ CHIRP
 - Garmin GMR™ 18 x HD Radome
 - Garmin GPSMap 1042xsv w/o Transducer
 - Garmin GPSMap 7612xsv w/o Transducer
 - Garmin Radar Cable & Power Cable
 - Garmin VHF Radio & Antenna
 - Upgrade Sound System (Fusion Transom Remote, Amp, 10" Sub and Wet Sounds LED Lighted Speakers)
 - Wet Sounds LED Lighted Speakers Upgrade

- Plumbing Options**
- Electric Marine Head w/ Overboard Discharge
 - Misting System (For Hard Top only)
 - Motor Flushing System
 - Porta Potti
 - Porta Potti (Pump Out)

- Seating Options**
- Bow Filler Cushion
 - Capt. Chair Upgrade (Adjustable Height Pedestal and Flip Up Arm Rest)
 - Port Side Aft Fold Out Seat (48")

- Optional Packages**
- Entertainment Package**
Ski Tow Bar, Removable Bow Table, Fusion/Wet Sounds Stereo System w/USB Port & Underwater LED Lights (3)
 - Galley Pack**
12v Fridge, Electric Grill w/ Inverter/ Battery Charger, Shore Power & Built-In 3 Bank Battery w/ LED Readout
 - Galley Pack Grill Delete**
 - QTP**
(Hard Top w/PDF Storage, Transom Rod Holders, Mid-Ship Fender Cleats, Flip Up Bow Light)

- Engine Options**
- Yamaha
- Twin F150XB
 - Twin F150XCA
 - Twin F200XB
 - Twin F200XCA
- Mercury
- Twin 150XL
 - Twin 200XL
 - Twin 200XL DTS
 - Twin Mercury White Motor Upgrade (Only Available on 200 HP and up)



FEATURES & OPTIONS

245DC

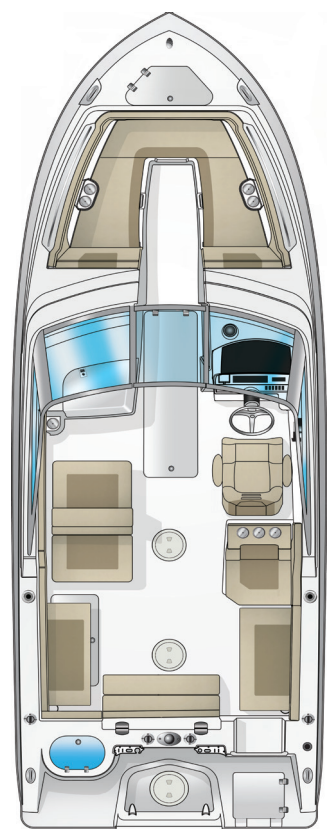

- Trim Tabs w/ Indicator Switch & Built in Retractor
- Walk Thru Transom Door with Wave Guard Step
- Yamaha 10 Micron Fuel Filter / Water Separator w/ SS Base
- Boat**
 - (2) 12 Volt Plugs
 - Bow Block Off Door
 - Bow Bottom and Backrest Cushions
 - Chaise Lounge Style Seating
- Electrical**
 - 12 Volt DC Accessory Plug
 - Accessory Switch Panel w/Circuit Breakers
 - Compass
 - Electric Horn
 - Full Digital Instrumentation
 - LED Interior Cockpit & Bilge Lighting
 - LED Navigational Bow & Anchor Light
- Hardware**
 - Fender Cleats Aft (2)
 - Flush Mount Hinges and Latches & Deck Plates
 - Heavy Duty Stainless Steel Bow & Stern Eyes
 - Heavy Duty Stainless Steel Rub Rail
 - Sailfish Engraved Transom Plate
 - Stainless Steel & Bronze Thru Hull Fittings
 - Stainless Steel Flush Mount Pull Up Cleats (6)
 - Stainless Steel Marine Grade Hardware
 - Stainless Steel Powder Coated Split Low Profile Bow Rails
 - Stainless Steel Propeller(s)
 - Stainless Steel Rod Holders (4)
- Head**
 - Finished Fiberglass Head
 - Head Compartment Lighting
 - Lockable Head Door
 - Mirror
 - SeaDek® Flooring
 - Sink w/ Faucet
 - SST Port Light
 - Towel Rack, TP Holder and Storage
- Helm**
 - Large Dash Area (Capable of flush Mounting 12" Electronics)
- Fishing**
 - Baitwell w/ LED Lighting (25 gal. Transom)
 - In-Floor Fish Box - Port Side AFT
 - Insulated Bow Fish Boxes with Overboard Drains
- Plumbing**
 - 14 gal. Freshwater Tank
 - Automatic Bilge Pump (2000 GPH Aft and 750 GPH Forward)
 - Freshwater Faucet - Head
 - Freshwater Shower - Transom
 - High Speed Livewell Pickup
 - Raw Water Wash Down
 - Self Bailing Cockpit
 - Sink with Faucet (Galley)
- Seating**
 - Aft Flip-Up Bolster Seating
 - Deluxe Billfish Captain's Chair with Flip Up Bolster
 - Flip Flop Lounge Seat w/ Storage, Built-in Insulated Cooler & Removable Cooler
 - Port Side AFT Fold Out Seat (36")
 - STB Aft Facing Seat
- Storage**
 - Anchor Locker (Finished Fiberglass w/ Anchor Management System)
 - Battery Storage (Bilge Compartment)
 - Fiberglass Console Storage
 - Glove Box - Helm
 - In Floor Ski Locker (Mid-Ship)
 - Recessed Rod Storage - STB Side
 - Storage Center In STB Passenger Seat Pod
- OPTIONS**
 - Boat Options**
 - 12 Volt Refrigerator (Must Order Galley Pack)
 - 2 Additional Rod Holders (In Splashwell)
 - Additional Table Base
 - Bow & Cockpit Covers
 - CL7 (C Series Motors Only)
 - Fiberglass Hard Top
 - Flip Up Bow Light (N/A w/ Windlass)
 - Hard Top Enclosure (3 Piece)
 - In-Floor Rod Storage (2)
 - Power Assist Steering (Standard w/ Verado)
 - Removable Bow Table
 - Two Tone Hard Top
 - Underwater LED Lights (2)
 - VesselView 502
 - Lewmar Bow Pre-Wire
 - Windlass w/ Polished Roller, SST Scuff Plate, SST Anchor, Rode & Chain
 - Windshield Wiper (Captain's Side) w/ Fresh Water
- Electrical Options**
 - Built-In 2 Bank Battery Charger w/ LED Readout
 - Built-In Solar Battery Charger, Hard Top Only
 - Fusion/Wet Sounds Stereo System & USB Port
 - Fusion Transom Remote Control
 - Garmin B60 Airmar Thru Hull Transducer w/o CHIRP
 - Garmin B75M Airmar Thru Hull Transducer w/ CHIRP
 - Garmin GPSMap 742xs w/o Transducer
 - Garmin GPSMap 1042xsv w/o Transducer
 - Garmin GPSMap 7612xsv w/o Transducer
 - Garmin GMR™ 18 x HD Radome
 - Garmin Radar Cable & Power Cable
 - Garmin VHF Radio & Antenna
 - Remote Spot Light for Hard Top
 - Upgrade Sound System (Fusion Transom Remote, Amp, 10" Sub and Wet Sounds LED Lighted Speakers)
 - Wet Sounds LED Lighted Speakers Upgrade
- Hardware Options**
 - Ski Tow Bar (Retractable)
- Plumbing Options**
 - Freshwater Electric Head w/Holding Tank, (with deck pump out fitting)
 - Misting System (For Hard Top only)
 - Porta Potti
 - Porta Potti (Pump Out)
- Seating Options**
 - Bow Filler Cushion
 - Capt. Chair Upgrade (Adjustable Height Pedestal & Flip Up Arm Rest)
 - STB Side Aft Fold Out Seat (36")
- Optional Packages**
 - **Entertainment Package** - Ski Tow Bar, Removable Bow Table, Fusion/Wet Sounds Stereo System, w/USB Port & Underwater LED Lights (2)
 - **Galley Pack** - Sink, Corian Countertops, Storage, (2) Cutting Boards & Removable Cooler
 - **QIP** - (Hard Top w/PFD Storage, Transom Rod Holders, Mid-Ship Fender Cleats, Flip Up Bow Light)
- Engine Options**
 - Yamaha**
 - F200XB
 - F250XB
 - F250XCA
 - F300XCA
 - White Painted Motor (300HP Only)
 - Mercury**
 - 200XL
 - 200XL DTS
 - 250XL Verado
 - 300XXL Verado
 - White Painted Motor (200HP and Up)

STANDARD FEATURES

- Boat**
 - Bimini Top
 - Boarding Ladder (4 step with grab handle)
 - Built-In Rigging Tubes (From Bilge to Helm w/ pull tapes)
 - Carbon Fiber & Kevlar® Reinforced Deck & Hull
 - Closed Cell Foam Flotation
 - Cockpit Bolster Pads
 - Corian Counter Tops (Head)
 - Exclusive Dot Matrix Non-Skid
 - Exclusive VDS Hull Design (Variable Deadrise Stepped Hull)
 - Hydraulic Steering w/ Tilt Stainless Steel Steering Wheel (Evo Pro w/ Leather Grips & Power Knob)
 - In-Floor Fish Box (w/ Advanced Vacuum Pump, Non-Macerated)
 - Mercury Verado Fuel Filter / Water Separator
 - Oversized Bilge Access
 - Powder Coated Walk Thru Windshield w/ Tempered Glass
 - Recessed SST Cup Holders (15)
 - SailTech Composite Full Length Transom
 - SailTech Foam Filled Fiberglass Stringer System
 - Transom Mounted Tool & Washdown Hose Holder

320EXP

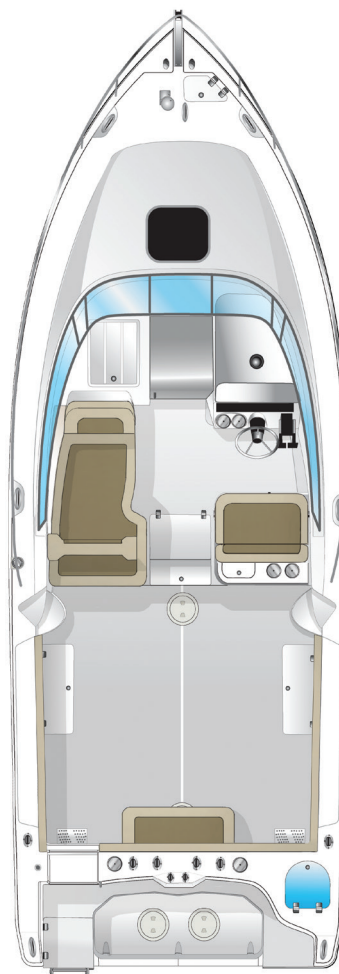

- Recessed SST Cup Holders (6)
- Remote Spot Light on Hard Top
- SailTech Composite Full Length Transom
- SailTech Foam Filled Fiberglass Stringer System
- Stainless Steering Wheel w/ Power Knob
- Walk Thru Transom Door with Wave Guard Step
- Windlass w/ SST Polished Anchor Roller, SST Polished Scuff Plate, SST Polished Anchor, Rode and Chain
- Yamaha 10 Micron Fuel Filter / Water Separator w/ SS Base
- Cabin Amenities**
 - Cabin V-Berth Cushions and Filler Cushions
 - Flip Up Bunk Beds
 - Fresh Water Marine Head w/ Holding Tank & Pump Out & Overboard Discharge
 - Galley Faucet at Sink
 - Hot Point Stove / Sink / Freshwater / Table / Microwave
 - Mid-Ship Berth
 - SST Port Lights (4)
 - Stand-up Head Compartment
- Electrical**
 - 12 Volt DC Accessory Plug
 - Accessory Switch Panel w/Circuit Breakers
 - Cabin Lighting
 - Compass
 - Full Digital Instrumentation
 - Heavy Duty High Performance Trim Tabs with Indicators & Auto Retract Feature
 - LED Interior Cockpit & Bilge Lighting
 - LED Navigational Bow & Anchor Light
 - Remote Control For Stereo at Helm
 - Shore Power w/ Built-In Battery Charger
 - Stereo (Bluetooth Capable, Satellite Ready, AM/FM w/4 Speakers)
 - Trim Tabs / High Performance / Heavy Duty With Indicator Switch & Built In Auto Retract Feature
 - VSR Battery Charging System
 - Windshield Wipers (Pair)
- Fishing**
 - Baitwell w/ LED Lighting (30 gal. Transom)
 - Built-In Tackle Storage (Mid-ship)
- Hardware**
 - Fender Cleats Aft (2)
 - Flush Mount Cleats
 - Flush Mount Hinges and Latches & Deck Plates
 - Heavy Duty Stainless Steel Bow & Stern Eyes
 - Heavy Duty Stainless Steel Rub Rail
 - Marine Grade Stainless Steel Hardware
 - Sailfish Engraved Transom Plate
 - Stainless Steel & Bronze Thru Hull Fittings
 - Stainless Steel Full Bow Rail
 - Stainless Steel Propeller(s)
 - Stainless Steel Rod Holders (10)
- Head**
 - Finished Fiberglass Head
 - Head Compartment Lighting
 - Lockable Head Door
 - Mirror
 - Pull Out Shower w/Sink in Head
- Helm**
 - Large Dash Area (Capable of flush mounting 15" Screen)
- Plumbing**
 - Automatic Bilge Pump (2 - 2000 GPH Aft - 750 GPH Forward)
 - Freshwater Showers (2) - Transom And Head
 - High Speed Livewell Pickup
 - Raw Water Wash Down
 - Self Bailing Cockpit (w/ (4) 2" Drains with Collector Box)
 - Sink with Faucet (In Cabin)
- Seating**
 - Oversized Captain's Chair With Flip Up Bolster
- Passenger Lounge Seat
- Storage**
 - Battery Storage (Bilge Compartment)
 - Recessed Rod Storage - Port & Starboard
 - Storage Center w/ Pull Out Drawers
 - Tackle Storage Port & Starboard
- OPTIONS**
 - Boat Options**
 - Air Conditioning / Heat & Air
 - CommandLink Plus (C Series Motors Only)
 - Generator Gas EFI 5KW
 - Mid-Ship Fender Cleats (2)
 - Power Assist Steering (Y)(Std. on T300HP)
 - Underwater LED Lights (3)
 - VesselView 7"
 - Electrical Options**
 - Garmin B60 Airmar Thru Hull Transducer w/o CHIRP
 - Garmin B75M Airmar Thru Hull Transducer w/ CHIRP
 - Garmin GPSMap 1042xsv w/o Transducer
 - Garmin GPSMap 7612xsv w/o Transducer
 - Garmin Radar Cable & Power Cable 30'
 - Garmin VHF Radio & Antenna
 - LED Lighted Speakers
 - Solar Battery Charger, Hard Top Only
 - Seating Options**
 - 58" Aft Folding Seat
 - Rear Cooler Seat - 125 Qt. Yeti
 - Optional Packages**
 - **Over Night Package** Generator Gas EFI 5KW & Air Conditioner
 - **Pilot House Package** Hard Top w/ Hard Frame Windshield w/ Wipers, Window Defroster & Back Drop Curtains
 - Engine Options**
 - Yamaha**
 - Twin F250UCA
 - Twin F300UCA
 - Mercury**
 - Twin 250XXL Verado
 - Twin 300XXL Verado
 - Twin 350XXL Verado
 - White Painted Motors (N/A on 250XXL)

STANDARD FEATURES

- Boat**
 - 6 Standard Hull Colors
 - Boarding Ladder (4 step with grab handle)
 - Built In Rigging Tubes (From Bilge to Helm with pull tapes)
 - Carbon Fiber & Kevlar® Reinforced Deck & Hull
 - Closed Cell Foam Flotation
 - Cockpit Bolsters
 - Exclusive Dot Matrix Non-Skid
 - Exclusive VDS Hull Design (Variable Deadrise Stepped Hull)
 - Full Hull Color
 - Hard Top w/ Storage, Lights and Rod Holders
 - Hydraulic Steering w/ Tilt Wheel & Power Knob
 - In-Floor Fish Boxes (Insulated w/ Advanced Vacuum Pump, Non-Macerated)
 - Mercury Verado Fuel Filter / Water Separator
 - Oversized Bilge Access
 - Power Assist Steering

For a complete listing of standard features and options visit sailfishboats.com

FEATURES & OPTIONS

270WAC

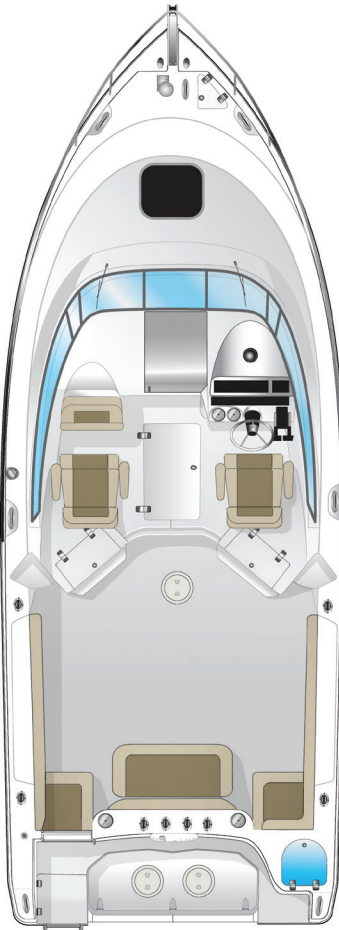

STANDARD FEATURES

- Boat**
- 6 Standard Hull Colors
 - Boarding Ladder (4 step with grab handle)
 - Built-in 48qt. Igloo Ice Cube™ Cooler
 - Built In Rigging Tubes (From Bilge to Helm with pull tapes)
 - Carbon Fiber & Kevlar® Reinforced Deck & Hull
 - Closed Cell Foam Flotation
 - Cockpit Bolsters
 - Cockpit Toe Rails
 - Exclusive Dot Matrix Non-Skid
 - Exclusive VDS Hull Design (Variable Deadrise Stepped Hull)
 - Full Hull Color
 - Hydraulic Steering w/ Stainless Steel Tilt Wheel & Power Knob
 - Mercury Verado Fuel Filter / Water Separator
 - Oversized Bilge Access
 - Polished Anchor Roller & SST Scuff Plate
 - Recessed SST Cup Holders (6)
 - SailTech Composite Full Length Transom
 - SailTech Foam Filled Fiberglass Stringer System
 - Transom Mounted Tool & Washdown Hose

- Holder**
- Walk Thru Transom Door with Wave Guard Step
 - Yamaha 10 Micron Fuel Filter / Water Separator w/ SS Base
- Cabin Amenities**
- Cabin Butane Stove / Sink / Freshwater / Table
 - Cabin V-Berth Cushions and Filler Cushions
 - Mirror
 - Stand-up Head Compartment
- Electrical**
- 12 Volt DC Accessory Plug
 - Accessory Switch Panel w/Circuit Breakers
 - Cabin Lighting
 - Compass
 - Electric Horn
 - Full Digital Instrumentation
 - Fusion/Wet Sounds Stereo System & USB Port
 - Heavy Duty High Performance Trim Tabs with Indicators & Auto Retract Feature
 - LED Interior Cockpit & Bilge Lighting
 - LED Navigational Bow & Anchor Light
 - Remote Control For Stereo at Helm
 - VSR Battery Charging System

- Fishing**
- Baitwell w/ LED Lighting (30 gal. Transom)
 - Built-In Tackle Storage Port Side (Midship)
- Hardware**
- Fender Cleats Aft (2)
 - Flush Mount Hinges and Latches & Deck Plates
 - Heavy Duty Stainless Steel Bow & Stern Eyes
 - Heavy Duty Stainless Steel Rub Rail
 - Marine Grade Stainless Steel Hardware
 - Sailfish Engraved Transom Plate
 - Stainless Steel & Bronze Thru Hull Fittings
 - Stainless Steel Flush Mount Pull-up Cleats (6)
 - Stainless Steel Full Bow Rail
 - Stainless Steel Propeller(s)
 - Stainless Steel Rod Holders (4)

- Head**
- Finished Fiberglass Head
 - Head Compartment Lighting
 - Lockable Head Door
 - Mirror

- Helm**
- Large Dash Area (Capable of flush mounting 12" Screen)

- Plumbing**
- Automatic Bilge Pump (2000 GPH Aft and 750 GPH Forward)
 - Freshwater Stations, (4) - Transom, Bait Prep Sink, Galley Sink and Head Sink
 - High Speed Livewell Pickup
 - Porta Potti
 - Pull Out Shower in Head
 - Pull Out Transom Shower
 - Raw Water Wash Down
 - Self Bailing Cockpit

- Seating**
- Captain's Chair Foot Rests
 - Captain's Chairs
 - Deluxe Passenger Chair

- Storage**
- Anchor Locker (w/ Bow Roller)
 - Battery Storage (Bilge Compartment)
 - Insulated -Fish Box with Overboard Drain (Midship)
 - Recessed Rod Storage - Port & Starboard
 - Tackle Storage Center w/ Pull Out Drawers

OPTIONS

- Boat Options**
- Bow Thruster
 - CL7 (C Series Motors Only)
 - Grand Slam Outriggers w/ 15' Poles (N/A on Pilot House)
 - Power Assist Steering (Standard w/

- Verado)
- Remote Spot Light for Hard Top
- Shore Power w/Built-in Battery Charger
- Underwater LED Lights (3)
- VesselView 502
- Lewmar Bow Pre-Wire
- Windlass w/ Polished Roller, SST Scuff Plate, Anchor, Rode & Chain
- Windshield Wipers (pair)

- Cabin Options**
- 12 Volt Refrigerator
 - Air Conditioning / Heat & Air
 - Hot Water Heater

- Electrical Options**
- Built-In Solar House Battery Charger (Hard Top Only)
 - Garmin B60 Airmar Thru Hull Transducer w/o CHIRP
 - Garmin B75M Airmar Thru Hull Transducer w/ CHIRP
 - Garmin GMR™18 x HD Radome
 - Garmin GPSMap 1042xsv w/o Transducer
 - Garmin GPSMap 7612xsv w/o Transducer
 - Garmin Radar Cable & Power Cable
 - Garmin VHF Radio & Antenna
 - Wet Sounds LED Lighted Speakers Upgrade

- Hardware Options**
- Ski Tow Bar (Retractable)

- Plumbing Options**
- Electric Marine Head w/ Overboard Discharge
 - Motor Flushing System

- Seating Options**
- 40" Aft Folding Seat
 - Port Side Lounge Seating
 - Rear Cooler Seat - 75 Qt. Yeti
 - Rear Jump Seats

- Optional Packages**
- **Cruise Package**
Rear Jump Seat & Rear Cooler Seat
 - **Pilot House Package**
Hard Top P.C., w/ Hard Frame Windshield w/ Wipers, Window Defroster & Back Drop Curtains
 - **Power Package**
Shore Power, Built-In Battery Charger, Refrigerator & Microwave
 - **Tournament Package**
Hard Top, P.C., w/PDF Storage, Built-In Radio Box & 2nd Tackle Organizer

- Engine Options**
- Yamaha**
- Twin F150XB
 - Twin F150XCA
 - Twin F200XB
 - Twin F200XCA
- Mercury**
- Twin 150XL
 - Twin 200XL
 - Twin 200XL DTS
 - Twin Mercury White Motor Upgrade (Only Available on 200 HP and Up)

240WAC

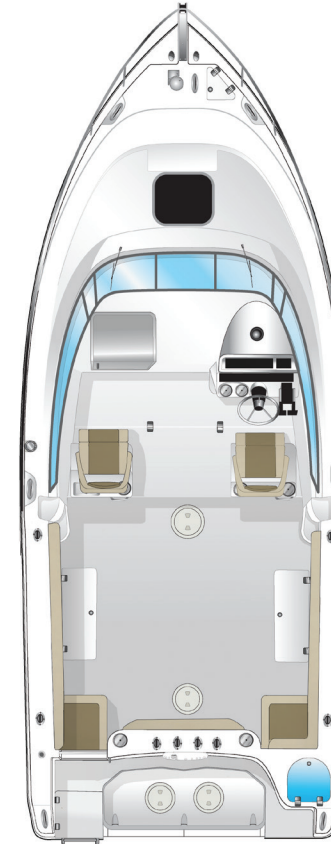

STANDARD FEATURES

- Boat**
- Anchor Locker (w/ Bow Roller)
 - Boarding Ladder (4 step with grab handle)
 - Built In Rigging Tubes (From Bilge to Helm with pull tapes)
 - Carbon Fiber & Kevlar® Reinforced Deck & Hull
 - Closed Cell Foam Flotation
 - Cockpit Bolsters
 - Exclusive Dot Matrix Non-Skid
 - Exclusive VDS Hull Design (Variable Deadrise Stepped Hull)
 - Faucet at Sink
 - Hydraulic Steering w/ Tilt Wheel & Power Knob
 - In-Floor Fish Box (w/ Advanced Vacuum Pump, Non-Macerated (2))
 - Mercury Verado Fuel Filter / Water Separator
 - Oversized Bilge Access
 - Recessed Rod Storage - Port & Starboard
 - Recessed SST Cup Holders(6)
 - SailTech Composite Full Length Transom
 - SailTech Foam Filled Fiberglass Stringer System
 - Stainless Steering Wheel w/ Power Knob
 - Transom Mounted Tool & Washdown Hose Holder
 - Walk Thru Transom Door with Wave Guard Step
 - Yamaha 10 Micron Fuel Filter / Water

- Separator w/ SS Base**
- Cabin Amenities**
- Cabin Butane Stove / Sink / Freshwater / Table
 - Cabin Lighting
 - Cabin V-Berth Cushions
 - Mirror
- Electrical**
- 12 Volt DC Accessory Plug
 - Accessory Switch Panel w/Circuit Breakers
 - Cabin Lighting
 - Compass
 - Full Digital Instrumentation
 - LED Interior Cockpit & Bilge Lighting
 - LED Navigational Bow & Anchor Light
 - Remote Control For Stereo at Helm
 - Stereo (Bluetooth Capable, Satellite Ready, AM/FM w/4 Speakers
 - VSR Battery Charging System

- Fishing**
- Baitwell w/ LED Lighting
 - 30 gal. Transom
 - Built-In Tackle Storage (Midship)

- Hardware**
- Bow Anchor Roller
 - Fender Cleats Aft (2)
 - Flush Mount Hinges and Latches & Deck Plates
 - Heavy Duty Stainless Steel Bow & Stern Eyes
 - Heavy Duty Stainless Steel Rub Rail
 - Marine Grade Stainless Steel Hardware
 - Sailfish Engraved Transom Plate
 - Stainless Steel & Bronze Thru Hull Fittings
 - Stainless Steel Flush Mount Pull-up Cleats (6)
 - Stainless Steel Full Bow Rail
 - Stainless Steel Propeller(s)
 - Stainless Steel Rod Holders (4)

- Helm**
- Large Dash Area (Capable of flush mounting 12" Screen)

- Plumbing**
- Automatic Bilge Pump (2000 GPH Aft and 750 GPH Forward)
 - Freshwater Showers Transom And Cabin
 - High Speed Livewell Pickup
 - Porta Potti
 - Raw Water Wash Down
 - Self Bailing Cockpit
 - Sink with Fresh Water Faucet (In Cabin)

- Seating**
- Captain's Chair Foot Rests
 - Captain's Chairs w/ Removable Cushions (2)

OPTIONS

- Boat Options**
- CommandLink Plus (C Series Motors Only)
 - Polished SST Anchor Scuff Plate
 - Power Assist Steering (M) (Standard w/ Verado)
 - Power Assist Steering (Y)
 - Remote Spot Light for Hard Top
 - SSI Tackle Station (Additional)
 - Trim Tabs w/ Indicator Switch & Built in Retractor
 - Underwater LED Lights (3)
 - VesselView 7"
 - Windlass w/ Polished Roller, SST Scuff Plate, Anchor, Rode & Chain
 - Windshield Wipers (pair)

- Electrical Options**
- Built-In 3 Bank Battery Charger w/ LED Readout
 - Garmin B60 Airmar Thru Hull Transducer w/o CHIRP
 - Garmin B75M Airmar Thru Hull Transducer w/ CHIRP
 - Garmin GPSMap 1042xsv w/o Transducer
 - Garmin VHF Radio & Antenna
 - LED Lighted Speakers
 - Solar Battery Charger, Hard Top Only

- Remote Spot Light for Hard Top Only
- Hardware**
- Mid-Ship Fender Cleats (2)
 - Ski Tow Bar (Retractable)
- Seating Options**
- 40" Aft Folding Seat
 - Rear Cooler Seat - 75 Qt. Yeti
 - Rear Jump Seats
- Optional Packages**
- **Cruise Package**
Rear Jump Seats, Rear Cooler Seat & Cabin Table w/ Pedestal & Cushion
 - **Tournament Package**
Hard Top w/ Built-In Radio Box & Transom Rod Holders (4)
 - **Pilot House Package**
Hard Top w/ Hard Frame Windshield w/ Wipers, Window Defroster & Back Drop Curtains

- Engine Options**
- Yamaha**
- F300UCA
 - F150XB
 - F150XCA
- Mercury**
- 150XL
 - 300XXL Verado
 - White Painted Motor (n/a on twin 150's)



FEATURES & OPTIONS

220WAC



- Cabin Lighting
 - Compass
 - Dual Battery Switch
 - Full Digital Instrumentation
 - LED Interior Cockpit & Bilge Lighting
 - LED Navigational Bow & Anchor Light
 - Remote Control For Stereo at Helm
 - Stereo (Bluetooth Capable, AM/FM w/4 Speakers)
 - Trim Tabs With Indicator Switch & Built In Auto Retract Feature
 - 12 Volt DC Accessory Plug
- Fishing**
- Baitwell w/ LED Lighting - 25 gal. Transom
 - Built-In Tackle Storage (Aft Under Transom Door)
- Hardware**
- Bow Anchor Roller
 - Fender Cleats Aft (2)
 - Flush Mount Hinges and Latches & Deck Plates
 - Heavy Duty Stainless Steel Bow & Stern Eyes
 - Heavy Duty Stainless Steel Rub Rail
 - Marine Grade Stainless Steel Hardware
 - Sailfish Engraved Transom Plate
 - Stainless Steel & Bronze Thru Hull Fittings
 - Stainless Steel Full Bow Rail
 - Stainless Steel Propeller(s)
 - Stainless Steel Rod Holders (4)
- Helm**
- Large Dash Area (Capable of flush mounting 10" Screen)
- Plumbing**
- Automatic Bilge Pump (2000 GPH)
 - Freshwater Showers (2) - Transom and Cabin
 - High Speed Livewell Pickup
 - Porta Potti
 - Raw Water Wash Down
 - Self Bailing Cockpit
 - Sink with Faucet (In Cabin)
- Storage**
- Anchor Locker (w/ Bow Roller)
 - Battery Storage (Bilge Compartment)
 - Insulated -Fish Box / Storage (Leaning Post)
 - Recessed Rod Storage - Port & Starboard
- Seating**
- Leaning Post (L/P 4) Fiberglass w/Fish Box & Cooler

OPTIONS

- Boat Options**
- 25 qt. Igloo Coolers (pr)
 - Bimini Top
 - CommandLink Plus (C Series Motors Only)
 - Leaning Post Cover
 - Underwater LED Lights (2)
 - VesselView 4"

Electrical Options

- Built-In 2 Bank Battery Charger
- Garmin B60 Airmar Thru Hull Transducer w/o CHIRP
- Garmin B75M Airmar Thru Hull Transducer w/ CHIRP
- Garmin GPSMap 74ixs w/o Transducer
- Garmin GPSMap 840xs w/o Transducer
- Garmin VHF Radio & Antenna
- Solar Battery Charger, Hard Top Only

Hardware Options

- Mid-Ship Fender Cleats (2)
- Ski Tow Bar (Retractable)

Seating Options

- Rear Jump Seats

Optional Packages

- **Offshore Tournament Pack** Hard Top, Powder Coated w/ Built-In Rod Box, Flush Mount Cleats & Transom Rod Holders (3)

Engine Options

- Yamaha**
- F150XB
 - F200XB
 - F200XCA
- Mercury**
- 150XL
 - 200XL Verado

STANDARD FEATURES

- Boat**
- Boarding Ladder (3 step)
 - Built In Rigging Tubes (From Bilge to Helm with pull tapes)
 - Carbon Fiber & Kevlar® Reinforced Deck & Hull
 - Closed Cell Foam Flotation
 - Cockpit Bolsters
 - Exclusive Dot Matrix Non-Skid
 - Exclusive VDS Hull Design (Variable Deadrise Stepped Hull)
 - Faucet at Sink
 - Hydraulic Steering w/ Tilt Wheel & Power Knob
 - Mercury Verado Fuel Filter / Water Separator
 - Recessed SST Cup Holders (5)
 - SailTech Composite Full Length Transom
 - SailTech Foam Filled Fiberglass Stringer System
 - Stainless Steering Wheel w/ Power Knob
 - Walk Thru Transom Door with Wave Guard Step
 - Yamaha 10 Micron Fuel Filter / Water Separator w/ SS Base
- Cabin Amenities**
- Cabin 25Qt. Cooler
 - Cabin Butane Stove / Sink / Freshwater / Table
 - Cabin V-Berth Cushions and Filler Cushions
 - Mirror
- Electrical**
- Accessory Switch Panel w/Circuit Breakers

2100BB

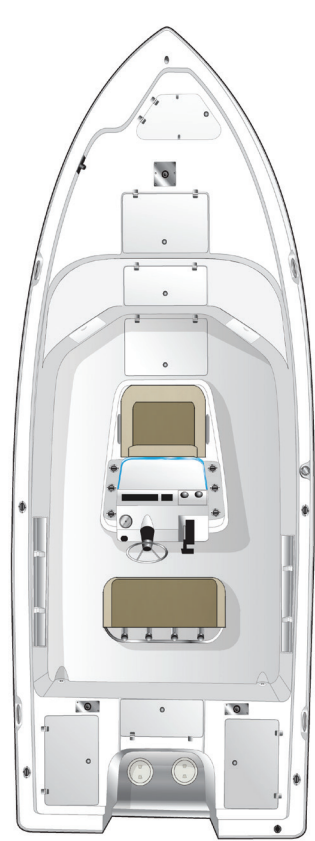

STANDARD FEATURES

- Boat**
- Anchor Locker
 - Built In Rigging Tubes (From Bilge to Helm with pull tapes)
 - Carbon Fiber & Kevlar® Reinforced Deck & Hull
 - Closed Cell Foam Flotation
 - Exclusive Dot Matrix Non-Skid
 - Hydraulic Steering w/ Tilt Wheel & Power Knob
 - Mercury Verado Fuel Filter / Water Separator
 - Recessed SST Cup Holders (1)
 - SailTech Composite Full Length Transom
 - SailTech Foam Filled Fiberglass Stringer System
 - Stainless Steering Wheel w/ Power Knob
 - Yamaha 10 Micron Fuel Filter / Water Separator w/ SS Base
- Electrical**
- 12 Volt DC Accessory Plug
 - Accessory Switch Panel w/Circuit Breakers
 - Compass
 - Dual Battery Switch
 - Electric Horn
 - Full Digital Instrumentation
 - LED Interior Cockpit Lighting
 - LED Navigational Bow & Anchor Light
- Fishing**
- Baitwell (20 gal. Aft)
 - Built-In Tackle Storage (2 Forward)
 - Insulated Bow Fish Box (5') - Drains

- Overboard**
- Release Livewell (30 gal. Port Aft)
- Hardware**
- Flush Mount Hinges and Latches & Deck Plates
 - Heavy Duty Stainless Steel Bow & Stern Eyes
 - Heavy Duty Stainless Steel Rub Rail
 - Marine Grade Stainless Steel Hardware
 - Sailfish Engraved Transom Plate
 - Stainless Steel Over Composite & Bronze Thru Hull Fittings
 - Stainless Steel Propeller(s)
 - Stainless Steel Rod Holders (8)
 - Wind Screen w/ Stainless Steel Grab Rail
- Helm**
- Large Dash Area (Capable of flush mounting 7" Screen)
- Plumbing**
- Automatic Bilge Pump (1100 GPH)
 - High Speed Livewell Pickup
 - Raw Water Wash Down
 - Self Bailing Cockpit
- Seating**
- Baitwell (16 gal. Console w/ Seat Cushions)
 - Captain's Chairs w/ Removable Cushions (2)
- Storage**
- Battery Storage (Aft Starboard)
 - Casting Deck Storage Box
 - In-Floor Storage (Forward of Console)
 - Recessed Rod Storage - Port & Starboard

OPTIONS

- Boat Options**
- Built-In 2 Bank Battery Charger
 - Flush Mount Cleats
 - Mid-Ship Fender Cleats (2)
 - Poling Platform
 - Powder Coated Leaning Post & T-Top
 - Swim Platform w/ Ladder
 - T-Top w. Spreader Light
 - Trim Tabs w/ Indicator Switch & Built in Retractor
 - Underwater LED Lights (2)

Electrical Options

- Garmin 547xs w/o Transducer
- Garmin B60 Airmar Thru Hull Transducer w/o CHIRP
- Garmin EchoMap 54dv US Blue Chart w/ P79 Transducer
- Garmin VHF Radio & Antenna
- Jensen Stereo w/2 Speakers
- LED Lighted Speakers
- Trolling Motor Panel

Seating Options

- Deluxe Fish Seat & Pedestal
- Front Jump Seat Cushions
- LP2 (Leaning Post w/ Rod Holders & Removable Backrest)
- Rear Jump Seat Cushions

Optional Packages

- **Sport Pack** Trolling Motor Panel, 2 Additional Rod Holders & Rear Jump Seat Cushions
- **Pro Fish Pack** (Includes Sport Pack), LP2 w/ Removable Backrest, Front Jump Seat Cushions & Flush Mount Cleats
- **Inshore Tournament Pack** Built-In Battery Charger, Deluxe Fish Seat & Pedestal

Engine Options

- Yamaha**
- F150XB
 - F200XB
 - F200XCA
- Mercury**
- 150XL
 - 200XL Verado

1900BB

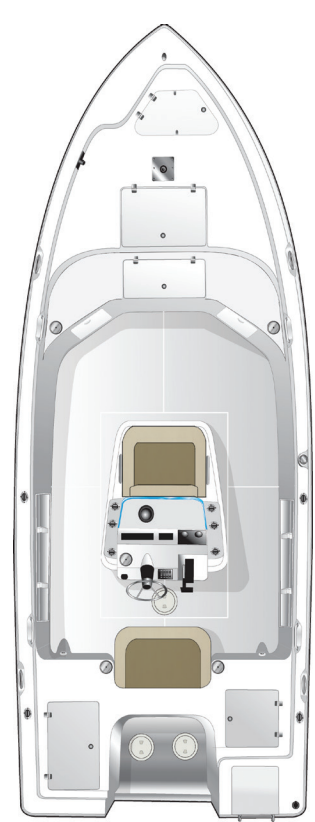

- Release Livewell (30 gal. Port Aft)
- Hardware**
- Flush Mount Hinges and Latches & Deck Plates
 - Heavy Duty Stainless Steel Bow & Stern Eyes
 - Heavy Duty Stainless Steel Rub Rail
 - Marine Grade Stainless Steel Hardware
 - Sailfish Engraved Transom Plate
 - Stainless Steel Over Composite & Bronze Thru Hull Fittings
 - Stainless Steel Propeller(s)
 - Stainless Steel Rod Holders (8)
 - Wind Screen with Stainless Steel Grab Rail
- Plumbing**
- Automatic Bilge Pump (1100 GPH)
 - High Speed Livewell Pickup
 - Raw Water Wash Down
 - Self Bailing Cockpit
- Seating**
- Baitwell (16 gal. Console w/ Seat Cushions)
 - Cooler Helm Seat (Removable 72 Qt. Igloo)
- Storage**
- Battery Storage (Under Helm Seat)
 - Casting Deck Storage Box
 - Recessed Rod Storage - Port & Starboard

OPTIONS

- Electrical Options**
- Garmin B60 Airmar Thru Hull Transducer w/o CHIRP
 - Garmin EchoMap 54dv US Blue Chart w/ P79 Transducer
 - Garmin GPSMAP 547xs w/o Transducer
 - Garmin VHF Radio & Antenna
 - Jensen Stereo w/2 Speakers
 - LED Lighted Speakers
 - Trolling Motor Panel

Boat Options

- Built-In 2 Bank Battery Charger
- Flush Mount Cleats
- Mid-Ship Fender Cleats (2)
- Poling Platform
- T-Top w. Spreader Light
- Trim Tabs w/ Indicator Switch & Built in Retractor
- Underwater LED Lights (2)

Seating Options

- Cooler Seat Backrest
- Deluxe Fish Seat & Pedestal
- Front Jump Seat Cushions
- Leaning Post w/ Backrest and Cooler
- Rear Jump Seat Cushions

Optional Packages

- **Sport Pack** Trolling Motor Panel, 2 Additional Rod Holders & Rear Jump Seat Cushions
- **Inshore Tournament Pack** Built-In Battery Charger, Deluxe Fish Seat & Pedestal

Engine Options

- Yamaha**
- F15XB
 - F150XB
- Mercury**
- 115ELPT
 - 150XL

STANDARD FEATURES

- Boat**
- Anchor Locker
 - Boarding Ladder (3 Step)
 - Built In Rigging Tubes (From Bilge to Helm with pull tapes)
 - Carbon Fiber & Kevlar® Reinforced Deck & Hull
 - Closed Cell Foam Flotation
 - Exclusive Dot Matrix Non-Skid
 - Hydraulic Steering w/ Tilt Wheel & Power Knob
 - Recessed SST Cup Holders (5)
 - SailTech Composite Full Length Transom
 - SailTech Foam Filled Fiberglass Stringer System
 - Stainless Steering Wheel w/ Power Knob
 - Yamaha 10 Micron Fuel Filter / Water Separator w/ SS Base
- Electrical**
- 12 Volt DC Accessory Plug
 - Accessory Switch Panel w/Circuit Breakers
 - Compass
 - Dual Battery Switch
 - Electric Horn
 - Full Digital Instrumentation
 - LED Interior Cockpit Lighting
 - LED Navigational Bow & Anchor Light
- Fishing**
- Built-In Tackle Storage (2 Forward)
 - Insulated Bow Fish Box (5') - Drains Overboard

For a complete listing of standard features and options visit www.sailfishboats.com



- 220CC**
 - Standard 13 16
 - Optional 28

- 220WAC**
 - Standard 13
 - Optional 28

- 241CC**
 - Standard 13 21 19
 - Optional 5 23

- 242CC**
 - Standard 13 16
 - Optional 6 7 28

- 240WAC**
 - Standard 30
 - Optional 18 28

- 245DC**
 - Standard 14 9 19 25 30
 - Optional 27

- 270CC**
 - Standard 1 17
 - Optional 2 3 4 13 18 25 28

- 275DC**
 - Standard 14 9 18 30
 - Optional 27

- 270WAC**
 - Standard 30
 - Optional 18 25 28 30

- 290CC**
 - Standard 1 17
 - Optional 2 3 4 10 18 25 28

- 320CC**
 - Standard 1 17
 - Optional 2 3 4 18 26

- 320WAC**
 - Standard 12 15
 - Optional 18 26

- 325DC**
 - Standard 11 8 22 30
 - Optional 27

- 360CC**
 - Standard 24 29
 - Optional 10 20

- 1900BB**
 - Standard 30
 - Optional 30

- 2100BB**
 - Standard 30
 - Optional 13 30

○ Helm & Leaning Post Seating ● Forward Helm Seating
● Aft Seating & Covers



35 Gallon Livewell Leaning Post with Flip Up Bolsters (LP5)



Capt. Chair Leaning Post w/ Expanded Tackle Stations (LP11)



35 Gallon Livewell Leaning Post with Capt Chairs (LP6)

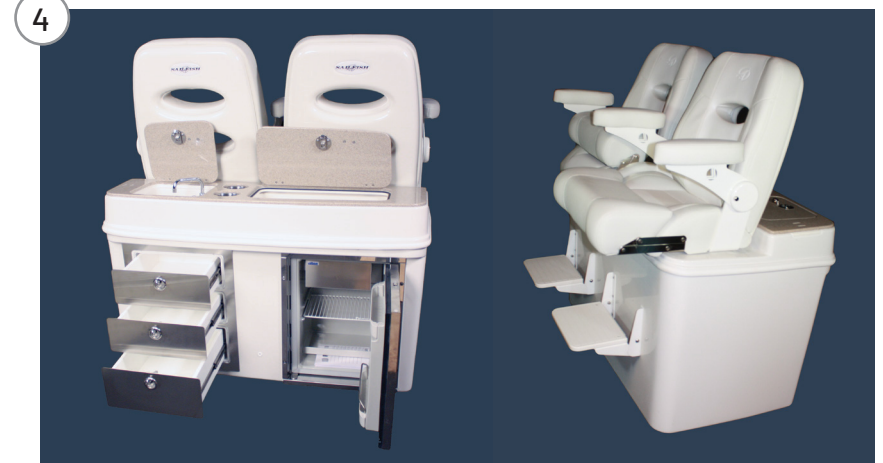

Entertainment Leaning Post with Capt Chairs (LP8)



Two Passenger Billfish Seat, Flip-Up Bolsters, Armrests & Tackle Storage (LP12)



Twin Billfish Chairs, Flip-Up Bolsters, Armrests & Tackle Storage (LP13)



SEATING OPTIONS



Leaning Post with Backrest and Igloo Cooler (LP4)



325DC Passenger Seat



245DC & 275DC Three Position Lounge



360 Utility Leaning Post w/Fridge, Grill, Corian Counter, Livewell & Landing for Cockpit Electronics



325DC Helm Seat



320WAC Passenger Lounge



LP2 with Removable Backrest



245DC & 275DC Capt Chair



320WAC Capt Chair



Forward Cooler Seat

SEATING OPTIONS



17 Forward Cooler Seat



18 Aft Folding Seat



19 241CC & 245DC AFT Seat w/ Flip Up Bolster



20 360CC Aft Starboard Stowaway Seat



21 241CC Forward Seat w/Built-In Cooler



22 Aft Stowaway Seat



23 241CC Rear Jump Seat



24 360CC Aft Stowaway Seat



25 Aft Cooler Seat 75 Qt Yeti



26 Aft Cooler Seat 125 Qt Yeti



27 Port & Starboard Aft Stowaway Seat



28 Twin Rear Jump Seats



COVERS & SHADES

29



360CC Rear Passenger Seat w/Cooler, Fridge, Tackle Storage and Landing for Cockpit Electronics



Console Cover - Available for 220CC thru 320CC



Center Console LP Cover 220CC Thru 360CC

30

NOT SHOWN

- FWD Bay Boat Seat
- 240WAC Helm Chairs
- 270WAC Captain's Chair
- 270 WAC Passenger Chair & Passenger Lounge
- Bay Boat FWD & Aft Jump Seats
- 1900BB Leaning Post w/ Backrest
- 1900BB Cooler Seat Backrest
- 1900BB Cooler Helm Seat - 72Qt. Igloo
- Deluxe Fishing Seat and Pedestal
- 245DC Rear Aft Facing Starboard Seat
- 325DC Fold Out Aft Passenger Seat 27"

For complete seating information visit www.SailfishBoats.com.



Dual Console Bow Cover

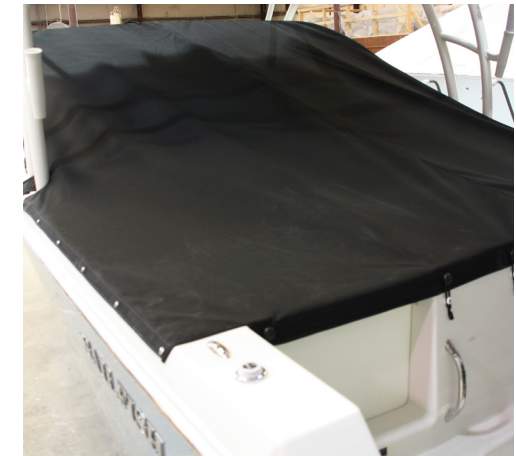

Dual Console Cockpit Cover

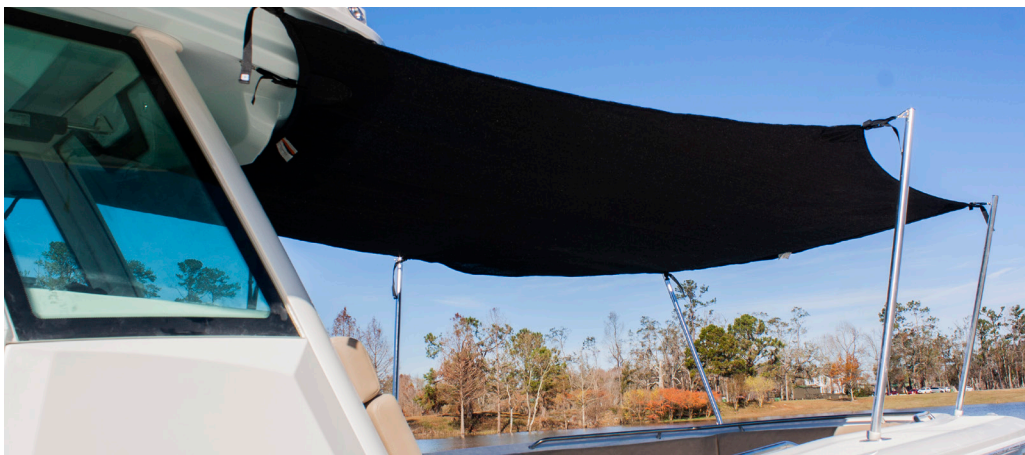

Center & Dual Console Bow Shade



275DC SureShade



Three Piece Enclosure

47



TOP OPTIONS

Hard Top



Deluxe Ladderback Hard Top

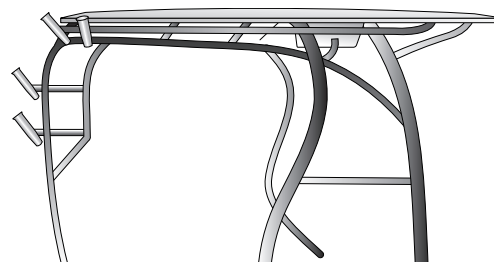

245DC Hard Top

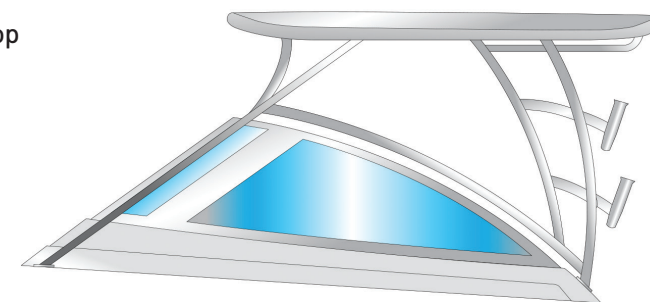

220 & 241CC Hard Top



Deluxe Hard Top

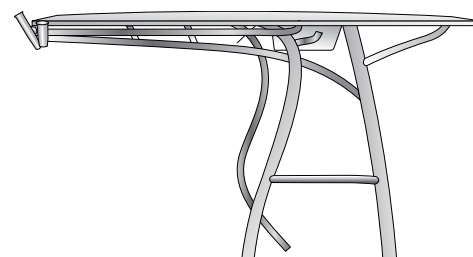

275DC Hard Top

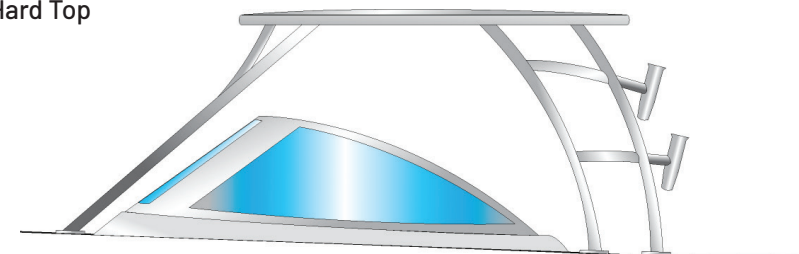

325DC Hard Top

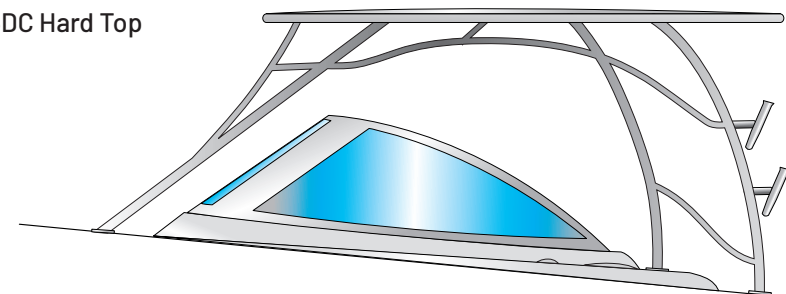

Center Console Hard Top Features – Fiberglass top, powder coated frame with hand holds, PFD storage (except on 220CC), electronics box with magnetic hold door, built in speakers, bi-color courtesy lights, rod holders and twin spreader lights.

Center Console Deluxe Hard Top Features – Deluxe fiberglass top, rugged oversized framework, powder coated frame with hand holds, PFD storage electronics box with magnetic hold door, built in speakers, bi-color courtesy lights, twin spreader lights, rear and trolling rod holders and docking lights.

Dual Console Hard Top Features – Full coverage fiberglass top with powder coated framework, PFD storage, electronic box with magnetic latch, built in speakers, bi-color courtesy lights and docking lights (325DC Only), rod holders, twin spreader lights, and an optional retractable shade (Standard on the 325DC).



HULL COLORS

Move up from standard White with any of the seven exciting color gelcoats to choose from, each masterfully applied and polished to the brightest possible shine. Solid color or two-tone gelcoat hulls are available.

BASIC COLORS

PREMIUM COLORS



White (Standard Color)



Bone



Black

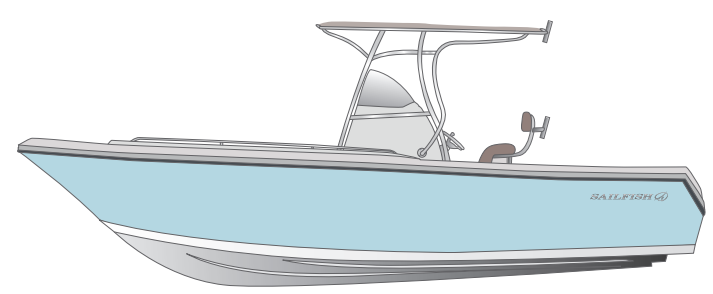

Province Blue



Ice Blue



Deep Blue

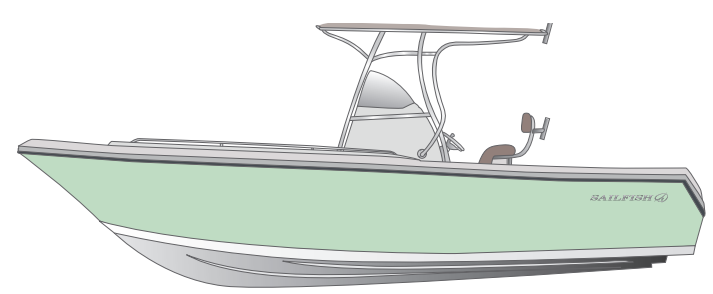

Surf Green



Iced Slate Grey

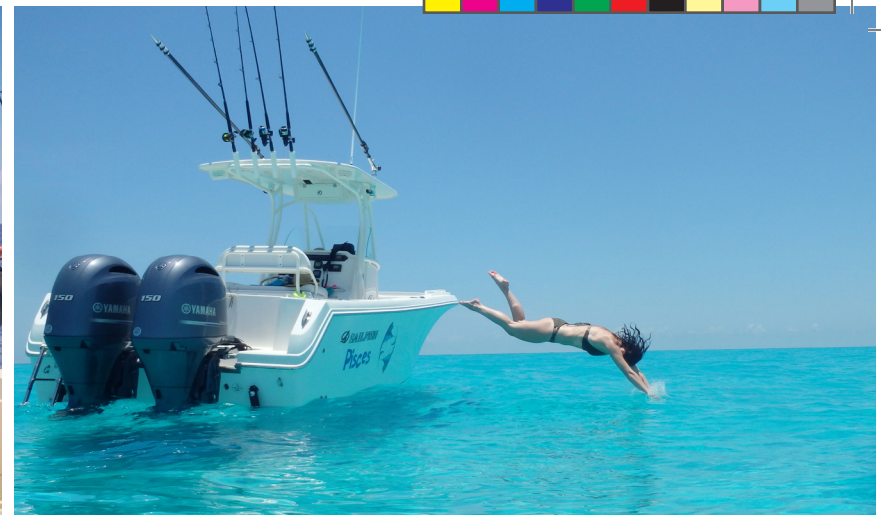

FOLLOW US ON SOCIAL MEDIA



@SAILFISHBOATS

View the full lineup, shop Sailfish merchandise and more at:

WWW.SAILFISHBOATS.COM

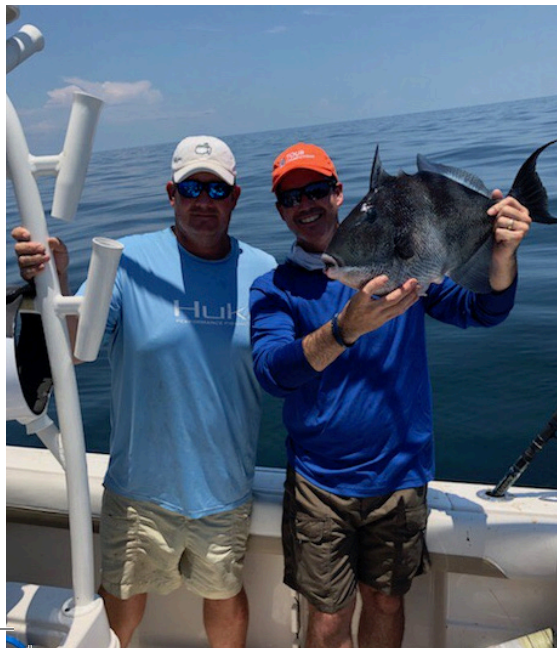



Manufactured by
SEMINOLE MARINE GROUP
2501 Industrial Park Drive • Cairo, GA 39828

www.Sailfishboats.com

Seminole Marine, Inc. reserves the right to discontinue models or change prices, specifications, materials, equipment, color or design at any time without incurring obligation. Weight and dimensions of all models are approximate and may vary. Options are subject to change. Photographs in this catalog were shot under supervised conditions with professional models and drivers and boats shown may contain optional equipment.