



SAILFISH

B O A T S







8
CENTER CONSOLES



22
DUAL CONSOLES

CONTENTS

CENTER CONSOLES

360CC	8
320CC	10
290CC	12
272CC	14
242CC	16
241CC	18
220CC	20

WALK AROUND

220WAC	26
--------------	----

HULL COLORS

.....	27
-------	----

DUAL CONSOLES

276DC	22
245DC	24



27
HULL COLORS



FISHING FOCUSED

At its core, Sailfish is a fishing boat designed by anglers for anglers. It is built to withstand the rigors of inshore and offshore environments and is loaded with more standard fishing features than any other boat on the water. We offer a wide range of options that allow you to customize your Sailfish for whatever type of fishing you wish to pursue. From inshore to deep water, 19 to 36 feet, you will find a Sailfish that will accommodate any fishing adventure or family outing.



FAMILY FRIENDLY

Every Sailfish has the built-in versatility to be a serious fishing boat one day and a family fun boat the next. With comfortable full bow seating, stow away tables, abundant storage space, a roomy head and a retractable ski tow bar, your Sailfish transforms into the perfect platform for an exciting family day on the water. Sailfish also provides for family safety with the highest cockpit depth in the industry – designed to keep water outside and people safely inside. Each Sailfish also features the largest recessed, cockpit drains in their class, allowing the maximum amount of water to exit the deck, providing for an extra level of safety.



ADVANCED DESIGN

INTELLIGENT ERGONOMICS

Have you ever been on a boat and thought, "Why on Earth did they do that?" Unless you're on a Sailfish, the answer is often because "they" added a feature as an afterthought. We design each boat with intelligent ergonomics from the start. When you reach for something, it's there—from cupholders, rod holders and hand-holds to switches, latches and toe rails. Our comfortable seating is ideal for lounging in the shallows or racing the sunrise offshore. All hinges and deck lids are recessed into the mounting surface, providing added safety for your feet. Plumbing and electrical systems are carefully engineered and installed for years of trouble-free operation and easy access.

INNOVATIVE DESIGN

For more than 30 years, our designers have set the standard for innovation in the industry. Features you'll find on many boats on the market today were first spotted on a Sailfish. We continue to push the industry forward—ensuring our boats have the best possible layout, design and functionality for anglers and families alike. Sailfish has the most standard premium features in our class and pioneering design elements you won't find on other boats.

LIFETIME NO-ROT GUARANTEE

Sailfish uses absolutely no wood in our transom or hull – that means a lifetime free of rotting, guaranteed! Our boats are made from 100% composite materials with stainless steel hardware. You will find many beautiful "fiberglass" boats on the water today that actually incorporate plywood encapsulated in fiberglass, which leaves them vulnerable to rotting. Enjoy the peace of mind that comes from Sailfish's all composite construction.

10-YEAR HULL WARRANTY

Each Sailfish boat comes with a 10-year hull warranty. Our hulls and decks are reinforced with Kevlar® and Carbon Fiber for greater durability, and the entire stringer system is foam-filled for added safety. All Sailfish boats are built using the best materials and proven manufacturing techniques. From start to finish, there are no shortcuts taken anywhere in the production process. Our quality control team takes great pride in ensuring your Sailfish is examined for flaws and imperfections before it leaves the plant.

VARIABLE DEGREE STEPPED HULL

Our exclusive Variable Degree Stepped (VDS) Hull design provides the smoothest ride of any fishing boat on the market. Its unique design features three distinct running surfaces. The first has a deep deadrise that cuts through the water, and two others that provide lift and stability. In addition, Sailfish has the deepest gunwales in its class, designed to keep passengers safely inside and water out. The beautiful, wide bow flare also aids in keeping water from blowing back into the boat. Whether you're idling or cutting through the surf, our VDS hull is the optimal design for a comfortable, safe ride.



SAILTECH CONSTRUCTION

EXCLUSIVE VARIABLE DEGREE STEPPED (VDS) HULL

1. The 24° hull cuts through the water. This is the most aggressive angle used in the fishing boat segment.
2. The 23° hull provides lift and allows air under the hull, producing a softer ride with less friction for better performance and fuel economy. This lift allows you to reach the same speed without requiring as much horsepower as other boat brands.
3. The 22° hull provides stability needed for slow trolling or stopped positions.

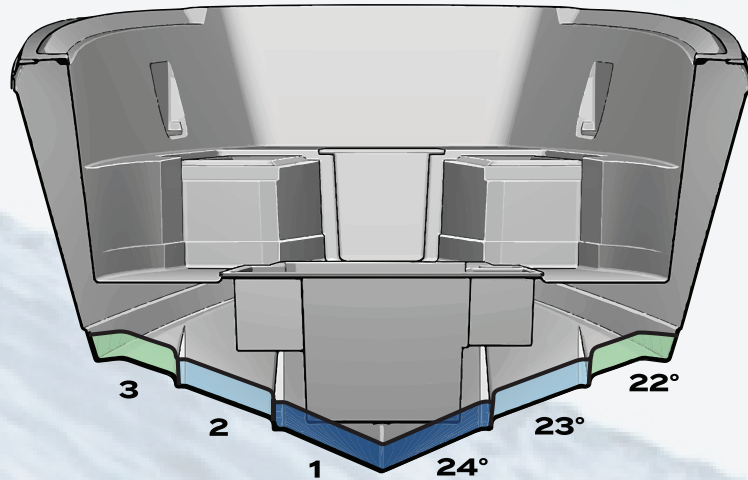

Lateral stepped hull that runs longitudinal from bow to stern.

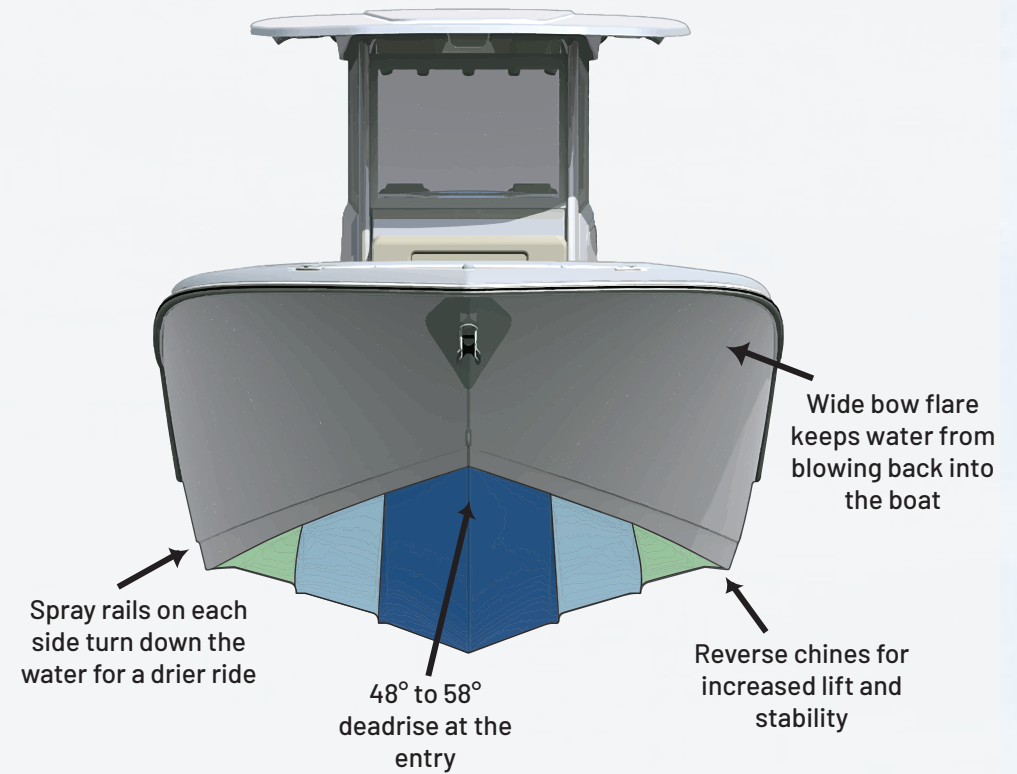

360CC

CENTER CONSOLE

36'

LOA HULL ONLY

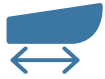

38'6"

LENGTH RIGGED



11'2"

BEAM



400 gal

FUEL CAPACITY



42 gal

FRESH WATER



15,695 lbs

WEIGHT



30"

COCKPIT DEPTH REAR



40"

BOW DEPTH



1050hp

MAX HP



28"

DRAFT HULL



22°-24°

DEAD RISE (MULTI-ANGLE)



8

BATTERY CAPACITY



34

ROD HOLDERS (STANDARD)



YC

(YACHT CERTIFIED) PERSON CAPACITY



9'10"

BRIDGE CLEARANCE (HARD TOP)





320CC

CENTER CONSOLE

31'6"
LOA HULL ONLY

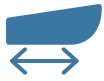

34'
LENGTH RIGGED



10'
BEAM



284gal
FUEL CAPACITY



21gal
FRESH WATER



10,500lbs
WEIGHT



31"
COCKPIT DEPTH REAR



40"
BOW DEPTH



700hp
MAX HP



22"
DRAFT HULL



22°-24°
DEAD RISE (MULTI-ANGLE)



3
BATTERY CAPACITY



30
ROD HOLDERS (STANDARD)



YC
(YACHT CERTIFIED)
PERSON CAPACITY



8'10"
BRIDGE CLEARANCE (HARD TOP)





290CC

CENTER CONSOLE

28'6"
LOA HULL ONLY

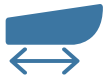

30'6"
LENGTH RIGGED



9'
BEAM



225gal
FUEL CAPACITY



14gal
FRESH WATER



8,000lbs
WEIGHT



30"
COCKPIT DEPTH REAR



40"
BOW DEPTH



600hp
MAX HP



21"
DRAFT HULL



22°-24°
DEAD RISE (MULTI-ANGLE)



3
BATTERY CAPACITY



16
ROD HOLDERS (STANDARD)



YC
(YACHT CERTIFIED)
PERSON CAPACITY



8'10"
BRIDGE CLEARANCE (HARD TOP)





272CC

CENTER CONSOLE

27'

LOA HULL ONLY



29'4"

LENGTH RIGGED



9'

BEAM



177 gal

FUEL CAPACITY



14 gal

FRESH WATER



6,850 bs

WEIGHT



32"

COCKPIT DEPTH REAR



8'6"

BRIDGE CLEARANCE (HARD TOP)



400 hp

MAX HP



18"

DRAFT HULL



22°-24°

DEAD RISE (MULTI-ANGLE)



3

BATTERY CAPACITY



27

ROD HOLDERS (STANDARD)



YC

(YACHT CERTIFIED) PERSON CAPACITY





242CC

CENTER CONSOLE

24'

LOA HULL ONLY

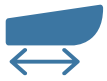

26'

LENGTH RIGGED



9'

BEAM



146gal
FUEL CAPACITY



14gal
FRESH WATER



5,600lbs
WEIGHT



30"

COCKPIT DEPTH REAR



40"

BOW DEPTH



300hp

MAX HP



18"

DRAFT HULL



22°-24°

DEAD RISE (MULTI-ANGLE)



3

BATTERY CAPACITY



12

ROD HOLDERS (STANDARD)



10

PERSON CAPACITY



8'6"

BRIDGE CLEARANCE (HARD TOP)





241CC

CENTER CONSOLE

24'
LOA HULL ONLY

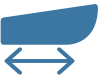

26'
LENGTH RIGGED



8'6"
BEAM



108gal
FUEL CAPACITY



14gal
FRESH WATER



5,000lbs
WEIGHT



27"
COCKPIT DEPTH REAR



32"
BOW DEPTH



300hp
MAX HP



18"
DRAFT HULL



22°-24°
DEAD RISE (MULTI-ANGLE)



2
BATTERY CAPACITY



12
ROD HOLDERS (STANDARD)



10
PERSON CAPACITY



8'6"
BRIDGE CLEARANCE (HARD TOP)





220CC

CENTER CONSOLE

21'3"
LOA HULL ONLY

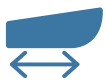

23'3"
LENGTH RIGGED



8'6"
BEAM



93gal
FUEL CAPACITY



6gal
FRESH WATER



4,450lbs
WEIGHT



26"
COCKPIT DEPTH REAR



32"
BOW DEPTH



200hp
MAX HP



18"
DRAFT HULL



22°-24°
DEAD RISE (MULTI-ANGLE)



2
BATTERY CAPACITY



10
ROD HOLDERS (STANDARD)



8
PERSON CAPACITY



8'4"
BRIDGE CLEARANCE (HARD TOP)





276DC

DUAL CONSOLE

27'

LOA HULL ONLY

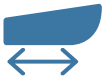

29'4"

LENGTH RIGGED



9'1"

BEAM



177 gal

FUEL CAPACITY



14 gal

FRESH WATER



7,050 lbs

WEIGHT



30"

COCKPIT DEPTH REAR



38"

BOW DEPTH



400hp

MAX HP



18"

DRAFT HULL



22°-24°

DEAD RISE (MULTI-ANGLE)



3

BATTERY CAPACITY



19

ROD HOLDERS (STANDARD)



YC

(YACHT CERTIFIED) PERSON CAPACITY



8'6"

BRIDGE CLEARANCE (HARD TOP)





245DC

DUAL CONSOLE

24'

LOA HULL ONLY

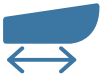

26'

LENGTH RIGGED



8'6"

BEAM



120gal

FUEL CAPACITY



14gal

FRESH WATER



5,350lbs

WEIGHT



27"

COCKPIT DEPTH REAR



8'5"

BRIDGE CLEARANCE (HARD TOP)



300hp

MAX HP



18"

DRAFT HULL



22°-24°

DEAD RISE (MULTI-ANGLE)



2

BATTERY CAPACITY



6

ROD HOLDERS (STANDARD)



12

PERSON CAPACITY





220 WAC WALK AROUND



21'3"
LOA HULL ONLY



23'6"
LENGTH RIGGED



8'6"
BEAM



93gal
FUEL CAPACITY



6gal
FRESH WATER



4,950lbs
WEIGHT



26"
COCKPIT DEPTH REAR



8
PERSON CAPACITY



200hp
MAX HP



18"
DRAFT HULL



22°-24°
DEAD RISE (MULTI-ANGLE)



2
BATTERY CAPACITY



8
ROD HOLDERS (STANDARD)



8'4"
BRIDGE CLEARANCE (HARD TOP)



Move up from standard White with any of the four exciting color gelcoats to choose from, each masterfully applied and polished to the brightest possible shine. Solid color or two-tone gelcoat hulls are available.

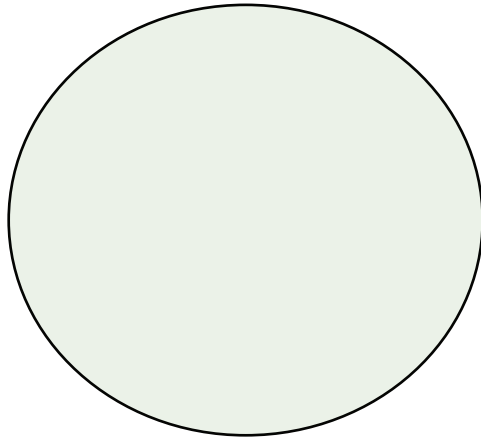

STANDARD - WHITE

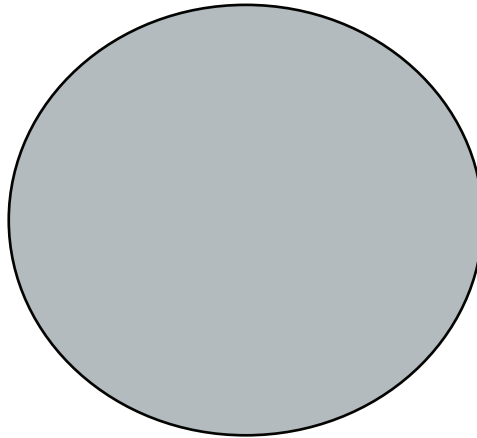

ICE SLATE

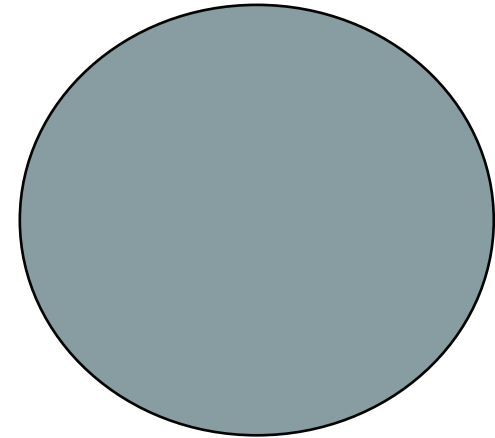

PROVINCE BLUE

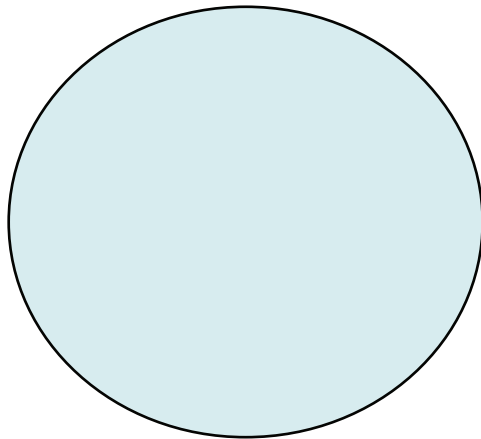

ICE BLUE

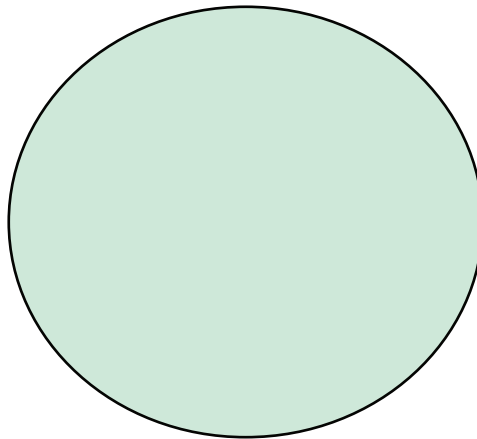

SURF GREEN



SAILFISH LIFESTYLE

For over three decades, Sailfish has delivered on a promise of quality and innovation with its full lineup of reliable, versatile, stylish boats including Center Console, Dual Console and Walk Around models. Our Sailfish family grows with every boat that is sold, and we invite you to join in on the fun. Meet the sunrise for an offshore angling adventure, make afternoon watersport waves with the family and gather friends for a sunset dinner cruise- all aboard your new Sailfish boat. We combine fishability for the serious angler and premium comfort and safety features for the family. Today's Sailfish lets you get more from your boating investment.





FOLLOW US ON SOCIAL MEDIA



@SAILFISHBOATS

View the full lineup, shop Sailfish merchandise and more at:

WWW.SAILFISHBOATS.COM





Manufactured by

SAILFISH BOATS

2501 Industrial Park Drive • Cairo, GA 39828

w w w . S a i l f i s h b o a t s . c o m

Sailfish Boats reserves the right to discontinue models or change prices, specifications, materials, equipment, color or design at any time without incurring obligation. Weight and dimensions of all models are approximate and may vary. Options are subject to change. Photographs in this catalog were shot under supervised conditions with professional models and drivers and boats shown may contain optional equipment. © 2021 Sailfish Boats. All Rights Reserved.